

TEST REPORT



Applicant	Shenzhen SOFAR SOLAR Co., Ltd.
Address	401, Building 4, AnTongDa Industrial Park, District 68, XingDong Community, XinAn Street, BaoAn District, Shenzhen, China.

Manufacturer or Supplier	Dongguan SOFAR SOLAR Co.,Ltd.	
Address	1F - 6F, Building E, No. 1 JinQi Road, Bihu Industrial Park, Wulian Village, Fenggang Town, Dongguan City	
Product	Hybrid Inverter	
Brand Name	SOFARSOLAR	
Model	HYD 6000-ES, HYD 4000-ES, HYD 3000-ES	
Additional Model & Model Difference	HYD 5000-ES, HYD 3600-ES, HYD 4600-ES; See items 2.1	
Date of tests	Sep. 03, 2018 ~Oct. 09, 2018	

The submitted sample of the above equipment has been tested according to the requirements of the following standards:

- EN 61000-6-3:2007 + A1:2011+ AC: 2012
- EN 61000-3-2:2014
- EN 61000-3-3:2013
- EN 61000-3-11:2001
- EN 61000-3-12:2011
- EN 61000-6-2:2005

CONCLUSION: The submitted sample was found to COMPLY with the test requirement

Tested by Ryan Lu Project Engineer / EMC Department	Approved by Glyn He Assistant Manager / EMC Department
	 Date: Sep. 20, 2019

This report is governed by, and incorporates by reference, CPS Conditions of Service as posted at the date of issuance of this report at <http://www.bureauveritas.com/home/about-us/our-business/cps/about-us/terms-conditions> and is intended for your exclusive use. Any copying or replication of this report to or for any other person or entity, or use of our name or trademark, is permitted only with our prior written permission. This report sets forth our findings solely with respect to the test samples identified herein. The results set forth in this report are not indicative or representative of the quality or characteristics of the lot from which a test sample was taken or any similar or identical product unless specifically and expressly noted. Our report includes all of the tests requested by you and the results thereof based upon the information that you provided to us. Measurement uncertainty is only provided upon request for accredited tests. You have 60 days from date of issuance of this report to notify us of any material error or omission caused by our negligence or if you require measurement uncertainty; provided, however, that such notice shall be in writing and shall specifically address the issue you wish to raise. A failure to raise such issue within the prescribed time shall constitute you unqualified acceptance of the completeness of this report, the tests conducted and the correctness of the report contents.



Table of Contents

RELEASE CONTROL RECORD	4
1 SUMMARY OF TEST RESULTS	5
1.1 MEASUREMENT UNCERTAINTY	7
2 GENERAL INFORMATION	8
2.1 GENERAL DESCRIPTION OF EUT	8
2.2 DESCRIPTION OF TEST MODES	9
2.3 GENERAL DESCRIPTION OF APPLIED STANDARDS	11
2.4 DESCRIPTION OF SUPPORT UNITS	11
3 EMISSION TEST	12
3.1 CONDUCTED EMISSION MEASUREMENT	12
3.1.1 LIMITS OF CONDUCTED EMISSION MEASUREMENT	12
3.1.2 TEST INSTRUMENTS	12
3.1.3 TEST PROCEDURE	13
3.1.4 DEVIATION FROM TEST STANDARD	13
3.1.5 TEST SETUP	13
3.1.6 EUT OPERATING CONDITIONS	13
3.1.7 TEST RESULTS	14
3.2 RADIATED EMISSION MEASUREMENT	16
3.2.1 LIMITS OF RADIATED EMISSION MEASUREMENT	16
3.2.2 TEST INSTRUMENTS	17
3.2.3 TEST PROCEDURE	18
3.2.4 DEVIATION FROM TEST STANDARD	19
3.2.5 TEST SETUP	20
3.2.6 EUT OPERATING CONDITIONS	20
3.2.7 TEST RESULTS	21
3.3 HARMONICS CURRENT MEASUREMENT	23
3.3.1 TEST INSTRUMENTS	23
3.3.2 DEVIATION FROM TEST STANDARD	23
3.3.3 TEST SETUP	23
3.3.4 EUT OPERATING CONDITIONS	23
3.3.5 TEST RESULTS	24
3.4 VOLTAGE FLUCTUATION AND FLICKS MEASUREMENT	27
3.4.1 TEST INSTRUMENTS	27
3.4.2 TEST PROCEDURE	27
3.4.3 DEVIATION FROM TEST STANDARD	27
3.4.4 TEST SETUP	27
3.4.5 EUT OPERATING CONDITIONS	27
3.4.6 TEST RESULTS	28
4 IMMUNITY TEST	29
4.1 GENERAL DESCRIPTION	29
4.1.1 GENERAL DESCRIPTION OF EN 61000-6-2	29
4.1.2 PERFORMANCE CRITERIA	30
4.1.3 EUT OPERATING CONDITION	30



4.2	ELECTROSTATIC DISCHARGE IMMUNITY TEST (ESD)	31
4.2.1	TEST SPECIFICATION	31
4.2.2	TEST INSTRUMENTS.....	31
4.2.3	TEST PROCEDURE.....	32
4.2.4	DEVIATION FROM TEST STANDARD.....	32
4.2.5	TEST SETUP.....	33
4.2.6	TEST RESULTS	34
4.3	RADIATED, RADIO-FREQUENCY, ELECTROMAGNETIC FIELD.....	36
	IMMUNITY TEST (RS)	36
4.3.1	TEST SPECIFICATION	36
4.3.2	TEST INSTRUMENTS.....	36
4.3.3	TEST PROCEDURE.....	37
4.3.4	DEVIATION FROM TEST STANDARD.....	37
4.3.5	TEST SETUP.....	37
4.3.6	TEST RESULTS	38
4.4	ELECTRICAL FAST TRANSIENT/BURST IMMUNITY TEST (EFT)	39
4.4.1	TEST SPECIFICATION	39
4.4.2	TEST INSTRUMENTS.....	39
4.4.3	TEST PROCEDURE.....	39
4.4.4	DEVIATION FROM TEST STANDARD.....	39
4.4.5	TEST SETUP.....	40
4.4.6	TEST RESULTS	41
4.5	SURGE IMMUNITY TEST	42
4.5.1	TEST SPECIFICATION	42
4.5.2	TEST INSTRUMENTS.....	42
4.5.3	TEST PROCEDURE.....	43
4.5.4	DEVIATION FROM TEST STANDARD.....	43
4.5.5	TEST SETUP.....	43
4.5.6	TEST RESULTS	44
4.6	IMMUNITY TO CONDUCTED DISTURBANCES INDUCED BY RF.....	45
	FIELDS (CS).....	45
4.6.1	TEST SPECIFICATION	45
4.6.2	TEST INSTRUMENTS.....	45
4.6.3	TEST PROCEDURE.....	46
4.6.4	DEVIATION FROM TEST STANDARD.....	46
4.6.5	TEST SETUP.....	47
4.6.6	TEST RESULTS	48
4.7	POWER FREQUENCY MAGNETIC FIELD IMMUNITY TEST	49
4.7.1	TEST SPECIFICATION	49
4.7.2	TEST INSTRUMENTS.....	49
4.7.3	TEST PROCEDURE.....	49
4.7.4	DEVIATION FROM TEST STANDARD.....	49
4.7.5	TEST SETUP.....	50
4.7.6	TEST RESULTS	51
5	PHOTOGRAPHS OF THE TEST CONFIGURATION	52
6	APPENDIX A – MODIFICATIONS RECORDERS FOR ENGINEERING CHANGES TO THE EUT BY THE LAB	57



BUREAU
VERITAS

Test Report No.: CE190808N030

RELEASE CONTROL RECORD

ISSUE NO.	REASON FOR CHANGE	DATE ISSUED
CE180903N042	Original release	Oct. 16, 2018
CE190808N030	Based on the original report CE180903N042 changed the information of applicant/ manufacturer, added additional model, but it doesn't need to be retested after engineer evaluated.	Sep. 20, 2019



1 SUMMARY OF TEST RESULTS

The EUT has been tested according to the following specifications:

EMISSION			
Standard	Test Type	Result	Remarks
EN 61000-6-3:2007 + A1:2011+ AC: 2012	Conducted test	PASS	Meets Limits Minimum passing margin is -2.28dB at 13.57031 MHz
	Radiated test (30MHz~1GHz)	PASS	Meets limits minimum passing margin is -0.60dB at 30.000 MHz
EN 61000-3-2:2014	Harmonic current emissions	PASS	Meets the requirements.
EN 61000-3-3:2013	Voltage fluctuations & flicker	PASS	Meets the requirements.
EN 61000-3-12:2011	Harmonic current emissions	PASS	Meets the requirements.
EN 61000-3-11:2001	Voltage fluctuations & flicker	PASS	Meets the requirements.



IMMUNITY (EN 61000-6-2:2005)			
Standard	Test Type	Result	Remarks
IEC 61000-4-2:2008 ED. 2.0	Electrostatic discharge immunity test	PASS	Electrostatic Discharge – ESD: 8kV Air discharge, 4kV Contact discharge, Performance Criterion A
IEC 61000-4-3:2010 ED. 3.2	Radiated, radio-frequency, electromagnetic field immunity test	PASS	Radio-Frequency Electromagnetic Field Susceptibility Test – RS: 80-1000 MHz, 10V/m, 80% AM (1kHz), 1400-2000 MHz, 3V/m, 80% AM (1kHz) 2000-2700 MHz, 1V/m, 80% AM (1kHz) Performance Criterion A
IEC 61000-4-4:2012 ED. 3.0	Electrical fast transient / burst immunity test.	PASS	Electrical Fast Transient/Burst - EFT AC Power line: 2kV, DC Power line 2kV, Performance Criterion A
IEC 61000-4-5:2014 ED. 3.0	Surge immunity test	PASS	Surge Immunity Test: 1.2/50 us Open Circuit Voltage, 8 /20 us Short Circuit Current, AC Power Line: line to line 1 kV, line to earth 2kV, DC Power Line: line to line 0.5kV Performance Criterion B
IEC 61000-4-6:2013 ED. 4.0	Immunity to conducted disturbances, induced by radio-frequency fields	PASS	Conducted Radio Frequency Disturbances Test – CS: 0.15-80 MHz, 10Vrms, 80% AM, 1kHz, Performance Criterion A
IEC 61000-4-8:2009 ED. 2.0	Power frequency magnetic field immunity test.	PASS	Power Frequency Magnetic Field Test, 50 Hz, 30A/m, Performance Criterion A



1.1 MEASUREMENT UNCERTAINTY

Where relevant, the following measurement uncertainty levels have been estimated for tests performed on the EUT as specified in CISPR 16-4-2:

This uncertainty represents an expanded uncertainty expressed at approximately the 95% confidence level using a coverage factor of $k=2$.

MEASUREMENT	FREQUENCY	UNCERTAINTY
Mains Terminal Disturbance Voltage Test	0.15MHz ~ 30MHz	+ /-2.70 dB
Radiated Disturbance Test	30MHz ~ 1000MHz	+ /-4.04 dB



2 GENERAL INFORMATION

2.1 GENERAL DESCRIPTION OF EUT

PRODUCT	Hybrid Inverter
MODEL NO.	HYD 6000-ES, HYD 4000-ES, HYD 3000-ES
ADDITIONAL MODELS	HYD 5000-ES, HYD 3600-ES, HYD 4600-ES
POWER SUPPLY	For HYD 6000-ES:DC input: 300V-520V AC output: 184V-276V, Battery: DC 40-60V For HYD 4000-ES:DC input: 200V-520V AC output: 184V-276V, Battery: DC 40-60V For HYD 3000-ES:DC input: 160V-520V AC output: 184V-276V, Battery: DC 40-60V
THE HIGHEST OPERATING FREQUENCY	Below 108MHz
DATA CABLE SUPPLIED	N/A

NOTE:

1. For the test results, the EUT had been tested with all conditions. But only the worst case was showed in test report.
2. For a more detailed features description, please refer to the manufacturer's specifications or the User's Manual.
3. Please refer to the EUT photo document (Reference No.: 190808N030) for detailed product photo.
4. Additional models HYD 5000-ES, HYD 3600-ES, HYD 4600-ES are identical with the test models HYD 6000-ES, HYD 4000-ES, HYD 3000-ES except the model number, power rating and software for trading purpose. The difference has been considered during this test, full test was performed for the model HYD 6000-ES, partial test was performed for the model HYD 4000-ES, test conduction emission and radiated emission, other partial test was performed for the model HYD 3000-ES, test conduction emission, radiated emission, harmonics and flicker.



2.2 DESCRIPTION OF TEST MODES

The EUT was tested under the following modes' the final worst mode was marked in boldface and recorded in this report.

◆ For Conducted Emission Test

Description of Test Mode	Test Model	Test Voltage
Grid	HYD 6000-ES	Input: DC 520V/12.69A,Output: AC 230V/50Hz Input: DC 410V/16.10A,Output: AC 230V/50Hz Input: DC 300V/22A,Output: AC 230V/50Hz
Grid+ Battery charging		Input: DC 520V/12.69A,Output: AC 230V/50Hz
Battery charging from AC input		AC230V/50Hz
Battery discharging+ Grid		Input: DC 48V from battery, Output: AC 230V/50Hz
Battery discharging+ AC output		Input: DC 48V from battery, Output: AC 230V/50Hz
Grid	HYD 4000-ES	Input: DC 520V/8.46A,Output: AC 230V/50Hz Input: DC 360V/12.22A,Output: AC 230V/50Hz
Grid+ Battery charging		Input: DC 520V/8.46A,Output: AC 230V/50Hz
Battery charging from AC input		AC230V/50Hz
Battery discharging+ Grid		Input: DC 48V from battery, Output: AC 230V/50Hz
Battery discharging+ AC output		Input: DC 48V from battery, Output: AC 230V/50Hz
Grid	HYD 3000-ES	Input: DC 520V/6.35A,Output: AC 230V/50Hz Input: DC 340V/9.71A,Output: AC 230V/50Hz
Grid+ Battery charging		Input: DC 520V/6.35A,Output: AC 230V/50Hz
Battery charging from AC input		AC230V/50Hz
Battery discharging+ Grid		Input: DC 48V from battery, Output: AC 230V/50Hz
Battery discharging+ AC output		Input: DC 48V from battery, Output: AC 230V/50Hz



◆ For Radiated Emission Test

Description of Test Mode	Test Model	Test Voltage
Grid	HYD 6000-ES	Input: DC 520V/12.69A, Output: AC 230V/50Hz Input: DC 410V/16.10A, Output: AC 230V/50Hz Input: DC 300V/22A, Output: AC 230V/50Hz
Grid+ Battery charging		Input: DC 300V/22A, Output: AC 230V/50Hz
Battery charging from AC input		AC230V/50Hz
Battery discharging+ Grid		Input: DC 48V from battery, Output: AC 230V/50Hz
Battery discharging+ AC output		Input: DC 48V from battery, Output: AC 230V/50Hz
Grid	HYD 4000-ES	Input: DC 520V/8.46A, Output: AC 230V/50Hz Input: DC 360V/12.22A, Output: AC 230V/50Hz
Grid+ Battery charging		Input: DC 360V/12.22A, Output: AC 230V/50Hz
Battery charging from AC input		AC230V/50Hz
Battery discharging+ Grid		Input: DC 48V from battery, Output: AC 230V/50Hz
Battery discharging+ AC output		Input: DC 48V from battery, Output: AC 230V/50Hz
Grid	HYD 3000-ES	Input: DC 520V/6.35, Output: AC 230V/50Hz Input: DC 340V/9.71A, Output: AC 230V/50Hz
Grid+ Battery charging		Input: DC 340V/9.71A, Output: AC 230V/50Hz
Battery charging from AC input		AC230V/50Hz
Battery discharging+ Grid		Input: DC 48V from battery, Output: AC 230V/50Hz
Battery discharging+ AC output		Input: DC 48V from battery, Output: AC 230V/50Hz



◆ For Harmonics and Flicker Tests

Description of Test Mode	Test Model	Test Voltage
Grid	HYD 6000-ES	Input: DC 520V/12.69A,Output: AC 230V/50Hz
	HYD 3000-ES	Input: DC 520V/8.46A,Output: AC 230V/50Hz

◆ For Immunity Tests

Description of Test Mode	Test Model	Test Voltage
Grid	HYD 6000-ES	Input: DC 520V/12.69A,Output: AC 230V/50Hz Input: DC 410V/16.10A,Output: AC 230V/50Hz Input: DC 300V/22A,Output: AC 230V/50Hz
Grid+ Battery charging		Input: DC 300V/22A,Output: AC 230V/50Hz
Battery charging from AC input		AC230V/50Hz
Battery discharging+ Grid		Input: DC 48V from battery, Output: AC 230V/50Hz
Battery discharging+ AC output		Input: DC 48V from battery, Output: AC 230V/50Hz

2.3 GENERAL DESCRIPTION OF APPLIED STANDARDS

The EUT has been tested and complied with the requirements of the following standards:

EN 61000-6-3:2007 + A1:2011+ AC: 2012

EN 61000-3-2:2014

EN 61000-3-3:2013

EN 61000-3-12:2011

EN 61000-3-11:2001

EN 61000-6-2:2005

IEC 61000-4-2:2008 ED. 2.0

IEC 61000-4-3:2010 ED. 3.2

IEC 61000-4-4:2012 ED. 3.0

IEC 61000-4-5:2014 ED. 3.0

IEC 61000-4-6:2013 ED. 4.0

IEC 61000-4-8:2009 ED. 2.0

Notes: The above IEC basic standards are applied with latest version if customer has no special requirement.

2.4 DESCRIPTION OF SUPPORT UNITS

The EUT has been tested as an independent unit without any other necessary accessory or support units.



3 EMISSION TEST

3.1 CONDUCTED EMISSION MEASUREMENT

3.1.1 LIMITS OF CONDUCTED EMISSION MEASUREMENT

FREQUENCY (MHz)	dBuV	
	Quasi-peak	Average
0.15 - 0.5	66 - 56	56 - 46
0.50 - 5.0	56	46
5.0 - 30.0	60	50

- Note:**
- (1) The lower limit shall apply at the transition frequencies.
 - (2) The limit decreases in line with the logarithm of the frequency in the range of 0.15 to 0.50 MHz.

3.1.2 TEST INSTRUMENTS

Equipment	Manufacturer	Model No.	Serial No.	Last Cal.	Next Cal.
EMI Test Receiver	Rohde&Schwarz	ESR7	101494	Mar. 21,18	Mar. 20,19
Artificial Mains Network	Rohde&Schwarz	ENV216	101173	Mar. 03,18	Mar. 02,19
Artificial Mains Network	Rohde&Schwarz	ESH3-Z5	100317	Apr. 11,18	Apr. 10,19
Voltage probe	SCHWARZBEC K	TK 9421	TK 9421-176	Jan. 17,18	Jan. 16,19
Test software	ADT	ADT_Cond_V 7.3.7	N/A	N/A	N/A

- NOTE:**
- 1. The test was performed in shielding Room 843.
 - 2. The calibration interval of the above test instruments is 12 months and the calibrations are traceable to CEPREI/CHINA, GRGT/CHINA and NIM/CHINA



3.1.3 TEST PROCEDURE

- a. The EUT was placed 0.4 meters from the conducting wall of the shielded room with EUT being connected to the power mains through a line impedance stabilization network (LISN). Other support units were connected to the power mains through another LISN. The two LISNs provide 50 Ohm/ 50uH of coupling impedance for the measuring instrument.
- b. Both lines of the power mains connected to the EUT were checked for maximum conducted interference.
- c. The frequency range from 150 kHz to 30 MHz was searched. Emission levels under (Limit – 20dB) were not recorded.

3.1.4 DEVIATION FROM TEST STANDARD

No deviation

3.1.5 TEST SETUP

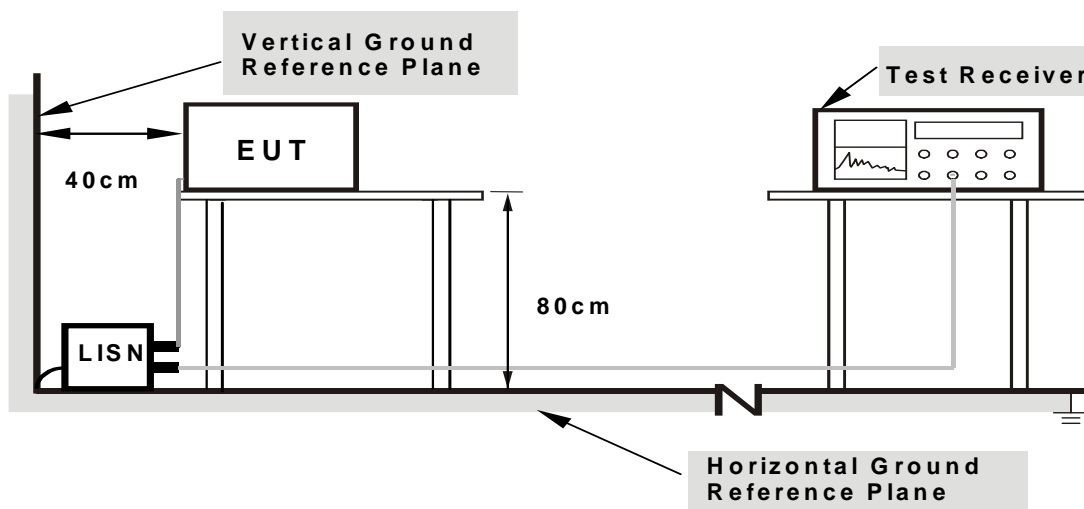

- Note:**
1. Support units were connected to second LISN.
 2. Both of LISNs (AMN) are 80cm from EUT and at least 80cm from other units and other metal planes support units.

3.1.6 EUT OPERATING CONDITIONS

- a. Turned on the power of all equipment.
- b. EUT was operated according to the type description in manufacturer's specifications or the User's Manual.



3.1.7 TEST RESULTS

TEST MODE	Battery charging from AC input	6dB BANDWIDTH	9 kHz
TEST VOLTAGE	AC230V/50Hz	PHASE	Line
ENVIRONMENTAL CONDITIONS	25 deg. C, 55% RH	TESTED BY: Jack	

No	Freq. [MHz]	Corr. Factor (dB)	Reading Value		Emission Level		Limit		Margin	
			[dB (uV)]		[dB (uV)]		[dB (uV)]		(dB)	
			Q.P.	AV.	Q.P.	AV.	Q.P.	AV.	Q.P.	AV.
1	0.15391	3.66	39.21	32.46	42.87	36.12	65.79	55.79	-22.92	-19.67
2	0.19297	7.70	31.08	27.66	38.78	35.36	63.91	53.91	-25.13	-18.55
3	0.27891	8.54	27.21	15.66	35.75	24.20	60.85	50.85	-25.10	-26.65
4	3.57031	9.23	31.57	30.82	40.80	40.05	56.00	46.00	-15.20	-5.95
5	4.42578	9.29	36.23	34.42	45.52	43.71	56.00	46.00	-10.48	-2.29
6	13.57031	9.48	39.57	38.24	49.05	47.72	60.00	50.00	-10.95	-2.28

REMARKS: The emission levels of other frequencies were very low against the limit.

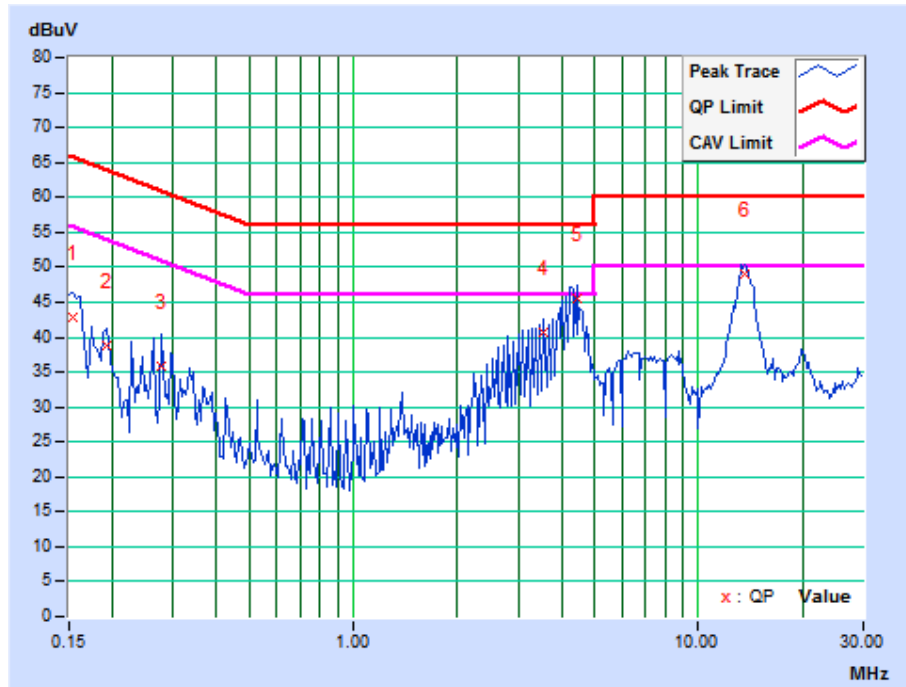



**BUREAU
VERITAS**

Test Report No.: CE190808N030

TEST MODE	Battery charging from AC input	6dB BANDWIDTH	9 kHz
TEST VOLTAGE	AC230V/50Hz	PHASE	Neutral (N)
ENVIRONMENTAL CONDITIONS	25 deg. C, 55% RH	TESTED BY: Jack	

No	Freq. [MHz]	Corr. Factor (dB)	Reading Value		Emission Level		Limit		Margin	
			[dB (uV)]		[dB (uV)]		[dB (uV)]		(dB)	
			Q.P.	AV.	Q.P.	AV.	Q.P.	AV.	Q.P.	AV.
1	0.15781	4.07	39.89	35.45	43.96	39.52	65.58	55.58	-21.62	-16.06
2	0.23594	8.40	25.98	19.85	34.38	28.25	62.24	52.24	-27.86	-23.99
3	0.27500	8.49	29.59	16.41	38.08	24.90	60.97	50.97	-22.89	-26.07
4	4.04688	9.26	25.76	25.18	35.02	34.44	56.00	46.00	-20.98	-11.56
5	8.90625	9.37	28.88	26.81	38.25	36.18	60.00	50.00	-21.75	-13.82
6	13.47656	9.49	35.70	34.48	45.19	43.97	60.00	50.00	-14.81	-6.03

REMARKS: The emission levels of other frequencies were very low against the limit.

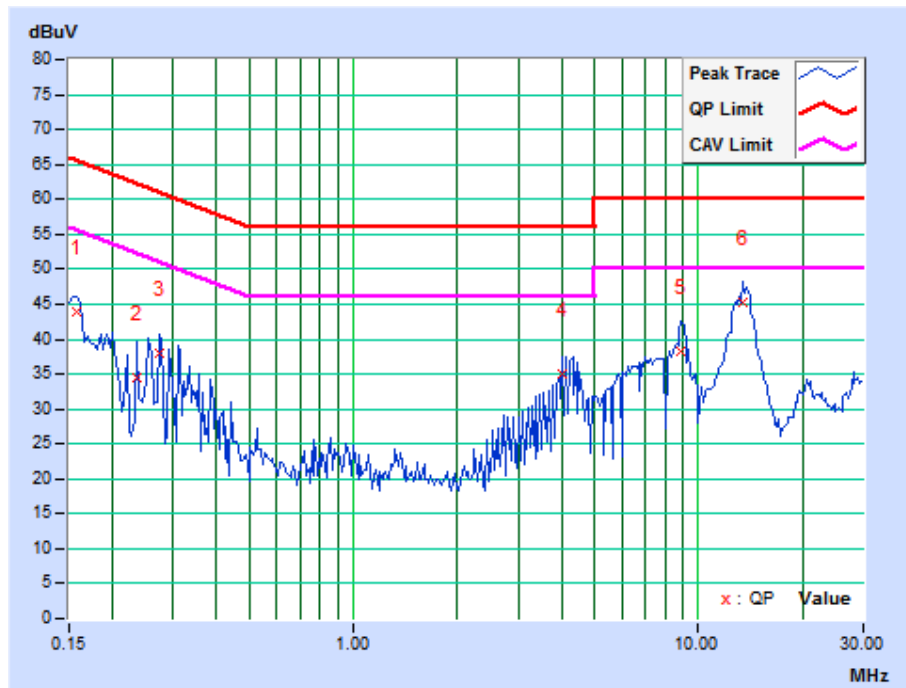



3.2 RADIATED EMISSION MEASUREMENT

3.2.1 LIMITS OF RADIATED EMISSION MEASUREMENT

TEST STANDARD: EN 61000-6-3

FREQUENCY RANGE OF RADIATED MEASUREMENT (For unintentional radiators)

Highest frequency generated or Upper frequency of measurement used in the device or on which the device operates or tunes (MHz)	Range (MHz)
Below 108	1000
108 – 500	2000
500 – 1000	5000
Above 1000	Up to 5 times of the highest frequency or 6 GHz, whichever is less

FOR FREQUENCY BELOW 1000 MHz

FREQUENCY (MHz)	3m	10m
	Quasi-Peak (dBuV/m)	Quasi-Peak (dBuV/m)
30 – 230	40	30
230 – 1000	47	37

FOR FREQUENCY ABOVE 1000 MHz

FREQUENCY (GHz)	3m	
	PEAK(dBuV/m)	AVERAGE(dBuV/m)
1 to 3	70	50
3 to 6	74	54

NOTE: (1) The lower limit shall apply at the transition frequencies.
(2) Emission level (dBuV/m) = 20 log Emission level (uV/m).



3.2.2 TEST INSTRUMENTS

FOR FREQUENCY BELOW 1GHz

Equipment	Manufacturer	Model No.	Serial No.	Last Cal.	Next Cal.
EMI Test Receiver	Rohde&Schwarz	ESU26	100005	Aug. 24,18	Aug. 23,19
EMI Test Receiver	Rohde&Schwarz	ESR7	101564	Jan. 18,18	Jan. 17,19
Trilog-Broadband Antenna	SCHWARZBECK	VULB 9168	9168-555	Nov. 10, 17	Nov. 09, 18
Trilog-Broadband Antenna	SCHWARZBECK	VULB 9168	9168-554	Dec. 10, 17	Dec. 09, 18
Preamplifier	EMCI	EMC1135	980378	Mar. 19,18	Mar. 18,19
Preamplifier	EMCI	EMC1135	980423	Mar. 19,18	Mar. 18,19
10m Semi-anechoic Chamber	CHANGLING	21.4m*12.1m*8.8m	NSEMC006	Feb. 10,18	Feb. 09,19
Test Software	ADT	ADT_Radiated_V8.7.07	N/A	N/A	N/A

- NOTES:** 1. The test was performed in 10m Chamber.
 2. The calibration interval of the above test instruments is 12 months. And the calibrations are traceable to CEPREI/CHINA, GRGT/CHINA and NIM/CHINA.

FREQUENCY RANGE ABOVE 1GHz

Equipment	Manufacturer	Model No.	Serial No.	Last Cal.	Next Cal.
Horn Antenna	ETS-Lindgren	3117	00085519	Dec. 10, 17	Dec. 09, 18
Horn Antenna	SCHWARZBECK	BBHA 9170	BBHA9170242	May 05,18	May 04,19
Signal and Spectrum Analyzer	Rohde&Schwarz	FSV40	101003	Apr. 21,18	Apr. 20,19
Broadband Preamplifier (1~18GHz)	SCHWARZBECK	BBV9718	266	Apr. 18,18	Apr. 18,19
Pre-Amplifier (18GHz-40GHz)	EMCI	EMC 184045	980102	Nov. 08,17	Nov. 07,18
Test Software	ADT	ADT_Radiated_V8.7.07	N/A	N/A	N/A

- NOTES:** 1. The test was performed in 10m Chamber.
 2. The calibration interval of the above test instruments are 12 months. And the calibrations are traceable to CEPREI/CHINA, GRGT/CHINA and NIM/CHINA.



3.2.3 TEST PROCEDURE

<Frequency Range below 1GHz>

- a. The EUT was placed on the top of a rotating table 0.8 meters above the ground at a 10 meter chamber room. The table was rotated 360 degrees to determine the position of the highest radiation.
- b. The EUT was set 10 meters away from the interference-receiving antenna, which was mounted on the top of a variable-height antenna tower.
- c. The height of antenna is varied from one meter to four meters above the ground to determine the maximum value of the field strength. Both horizontal and vertical polarizations of the antenna are set to make the measurement.
- d. For each suspected emission, the EUT was arranged to its worst case and then the antenna was tuned to heights from 1 meter to 4 meters and the turn table was turned from 0 degrees to 360 degrees to find the maximum reading.
- e. The test-receiver system was set to quasi-peak detect function and specified bandwidth with maximum hold mode when the test frequency is below 1 GHz.

NOTE:

1. The resolution bandwidth of test receiver/spectrum analyzer is 120kHz for Quasi-peak detection (QP) at frequency below 1GHz.
2. Emission level(dBuV/m)=Raw Value(dBuV) + Correction Factor(dB/m)
3. Correction Factor(dB/m) = Antenna Factor (dB/m) + Cable Factor (dB) (if the raw value not contains the amplifier);
4. Correction Factor(dB/m) = Antenna Factor (dB/m) + Cable Factor (dB) – Amplifier Gain(dB) (if the raw value contains the amplifier).
5. Margin value = Emission level – Limit value.



<Frequency Range above 1GHz>

- a. The EUT was placed on the top of a rotating table 0.8 meters above the ground at a 10 meter Semi-anechoic chamber room. The table was rotated 360 degrees to determine the position of the highest radiation.
- b. The EUT was set 3 meters away from the interference-receiving antenna, which was mounted on the top of a variable-height antenna tower.
- c. The height of antenna can be varied from one meter-to four meters, the height of adjustment depends on the EUT height and the antenna 3dB beamwidth both, to detect the maximum value of the field strength. Both horizontal and vertical polarizations of the antenna are set to make the measurement. The bore sight should be used during the test above 1GHz.
- d. For each suspected emission, the EUT was arranged to its worst case and then the antenna was tuned to heights and the rotatable table was turned from 0 degrees to 360 degrees to find the maximum reading.
- e. The test receiver/spectrum was set to peak and average detect function and specified bandwidth with maximum hold mode when the test frequency is above 1 GHz.

NOTE:

1. The resolution bandwidth is 1MHz and video bandwidth of test receiver/spectrum analyzer is 3MHz for Peak detection at frequency above 1GHz. The resolution bandwidth of test receiver/spectrum analyzer is 1 MHz for Average detection (AV) at frequency above 1GHz.
2. For measurement of frequency above 1000 MHz, the EUT was set 3 meters away from the receiver antenna.
3. Emission level(dBuV/m)=Raw Value(dBuV) + Correction Factor(dB/m)
4. Correction Factor (dB/m) = Antenna Factor (dB/m) + Cable Factor (dB) (if the raw value not contains the amplifier).
5. Correction Factor (dB/m) = Antenna Factor (dB/m) + Cable Factor (dB) – Amplifier Gain (dB) (if the raw value contains the amplifier).
6. Margin value = Emission level – Limit value.

3.2.4 DEVIATION FROM TEST STANDARD

No deviation



3.2.5 TEST SETUP

<Frequency Range below 1GHz>

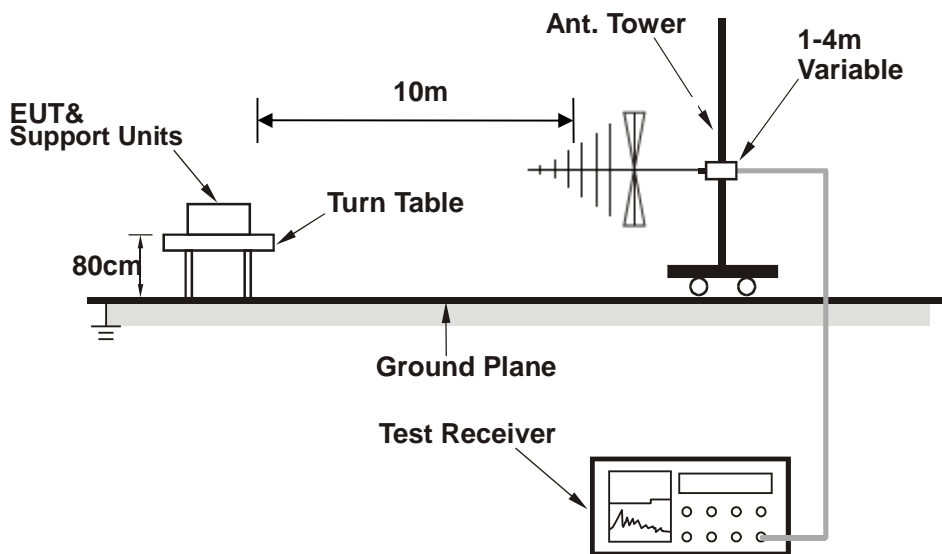

<Frequency Range above 1GHz>

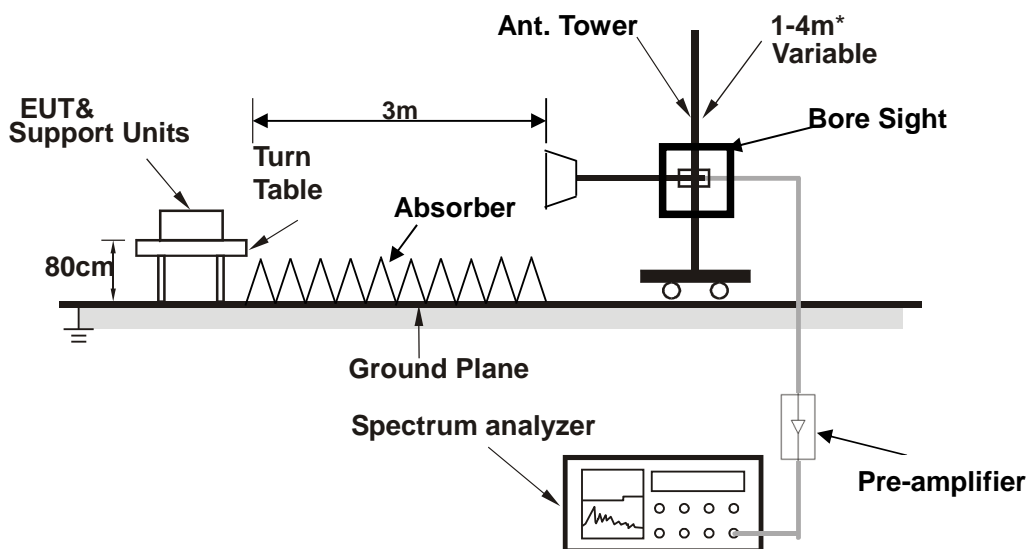

* :depends on the EUT height and the antenna 3dB beamwidth both, refer to section 7.3 of CISPR 16-2-3.

3.2.6 EUT OPERATING CONDITIONS

Same as item 3.1.6



3.2.7 TEST RESULTS

TEST MODE	Battery charging from AC input	FREQUENCY RANGE	30-1000 MHz
TEST VOLTAGE	AC230V/50Hz	DETECTOR FUNCTION & BANDWIDTH	Quasi-Peak, 120kHz
ENVIRONMENTAL CONDITIONS	23 deg. C, 67% RH	TESTED BY: Luke	

ANTENNA POLARITY & TEST DISTANCE: HORIZONTAL AT 10 M								
No.	Freq. (MHz)	Correction Factor (dB/m)	Raw Value (dBuV)	Emission Level (dBuV/m)	Limit (dBuV/m)	Margin (dB)	Antenna Height (cm)	Table Angle (Degree)
1	43.944	-17.32	35.01	17.69	30.00	-12.31	400	145
2	54.856	-17.83	35.40	17.57	30.00	-12.43	200	329
3	135.973	-18.11	31.92	13.81	30.00	-16.19	400	154
4	167.255	-17.22	34.58	17.36	30.00	-12.64	400	150
5	232.366	-17.85	35.14	17.29	37.00	-19.71	400	81
6	292.991	-15.55	35.54	19.99	37.00	-17.01	400	3

- REMARKS:**
1. Peak detector quick scan is showed on the graph and final quasi-peak detector data is measured corresponding to relevant limit and recorded in the data table.
 2. Negative sign (-) in the margin column signify levels below the limit.
 3. Frequency range scanned: 30MHz to 1000MHz.
 4. Only emissions significantly above equipment noise floor are reported

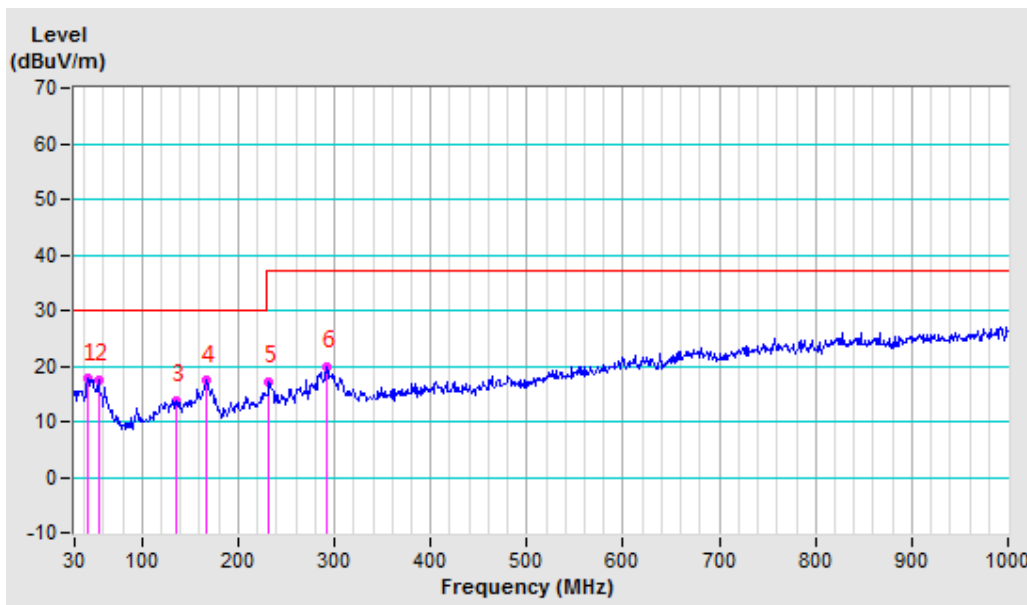



TEST MODE	Battery charging from AC input	FREQUENCY RANGE	30-1000 MHz
TEST VOLTAGE	AC230V/50Hz	DETECTOR FUNCTION & BANDWIDTH	Quasi-Peak, 120kHz
ENVIRONMENTAL CONDITIONS	23 deg. C, 67% RH	TESTED BY: Luke	

ANTENNA POLARITY & TEST DISTANCE: VERTICAL AT 10 M								
No.	Freq. (MHz)	Correction Factor (dB/m)	Raw Value (dBuV)	Emission Level (dBuV/m)	Limit (dBuV/m)	Margin (dB)	Antenna Height (cm)	Table Angle (Degree)
1	30.000	-19.01	48.41	29.40	30.00	-0.60	100	124
2	44.784	-17.91	46.61	28.70	30.00	-1.30	100	125
3	62.497	-19.37	44.47	25.10	30.00	-4.90	100	98
4	87.718	-21.65	39.93	18.28	30.00	-11.72	100	73
5	170.027	-16.63	35.07	18.44	30.00	-11.56	100	124
6	260.726	-15.95	38.30	22.35	37.00	-14.65	100	301

- REMARKS:**
1. Peak detector quick scan is showed on the graph and final quasi-peak detector data is measured corresponding to relevant limit and recorded in the data table.
 2. Negative sign (-) in the margin column signify levels below the limit.
 3. Frequency range scanned: 30MHz to 1000MHz.
 4. Only emissions significantly above equipment noise floor are reported

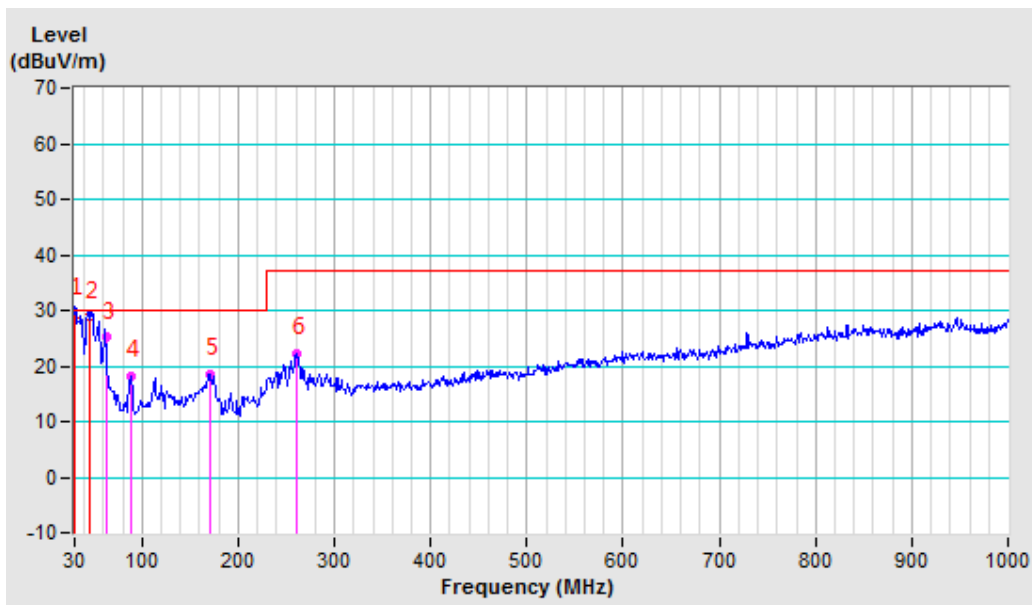



3.3 HARMONICS CURRENT MEASUREMENT

3.3.1 TEST INSTRUMENTS

TEST STANDARD: EN 61000-3-2 and EN 61000-3-12

DESCRIPTION & MANUFACTURER	MANUFACTURER	MODEL NO.	SERIAL NO.	CALIBRATED DATE	CALIBRATED UNTIL
PRECISION POWER ANALYZER	YOKOGAWA	WT3000	91M210852	Mar. 10,18	Mar. 11,19
Test Software	YOKOGAWA	IEC61000	N/A	N/A	N/A
PEFERENCE IMPEDANCE NETWORK	Voltech	EUR	3018	Apr. 08,18	Apr. 09,19

NOTE: 1. The test was performed in PV Room.
 2. The calibration interval of the above test instruments is 12 months and the calibrations are traceable to CEPREI/CHINA and NIM/CHINA.

3.3.2 DEVIATION FROM TEST STANDARD

No deviation

3.3.3 TEST SETUP

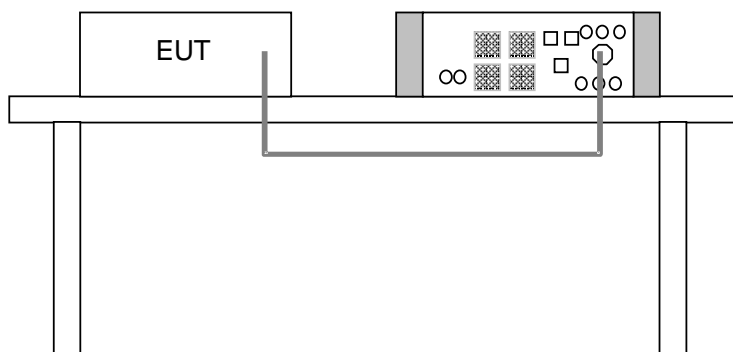

3.3.4 EUT OPERATING CONDITIONS

Same as item 3.1.6



3.3.5 TEST RESULTS

FOR MODEL HYD 3000-ES

Average

Regulation : IEC61000-3-2 Ed3.0 am2
 IEC61000-4-7 Ed2.0 A1
 Class : CLASS A
 MeasureTime : 149.80sec
 Model : YOKOGAWA WT3000
 Rating Voltage : 230.00 V
 Wiring : single-phase 2-wire
 Element : 1
 Range : 300V/30A
 Current(rms) : 13.4895 A
 Voltage(rms) : 230.54 V
 Frequency : 50.000 Hz
 Power Factor : 0.9933
 POHC Limit : 0.2514 A
 POHC Max : 0.0441 A
 THC : 0.2281 A

PASS

Set Fundamental I : -----
 Set Power Factor : -----
 Set P : -----
 Sigma W Max : 3091.754 W
 Sigma PF : 0.9933
 Distortion factor(V) : 0.05 %
 V THDS : 0.05 %
 V THDG : 0.05 %
 Distortion factor(A) : 1.61 %
 A THDS : 1.65 %
 A THDG : 1.69 %
 P THD : 0.00 %
 Power Limit : 75 W

Order	Measure[A]	Limit[A]	Margin[%]	Order	Measure[A]	Limit[A]	Margin[%]
1	13.4876			2	0.0265	1.0800	97.5
3	0.1968	2.3000	91.4	4	0.0206	0.4300	95.2
5	0.0733	1.1400	93.6	6	0.0155	0.3000	94.8
7	0.0451	0.7700	94.1	8	0.0132	0.2300	94.3
9	0.0260	0.4000	93.5	10	0.0110	0.1840	94.0
11	0.0159	0.3300	95.2	12	0.0083	0.1533	94.6
13	0.0144	0.2100	93.1	14	0.0069	0.1314	94.7
15	0.0139	0.1500	90.7	16	0.0063	0.1150	94.5
17	0.0143	0.1324	89.2	18	0.0057	0.1022	94.4
19	0.0159	0.1184	86.6	20	0.0053	0.0920	94.3
21	0.0158	0.1071	85.2	22	0.0056	0.0836	93.3
23	0.0152	0.0978	84.5	24	0.0055	0.0767	92.8
25	0.0156	0.0900	82.6	26	0.0137	0.0708	80.6
27	0.0147	0.0833	82.4	28	0.0051	0.0657	92.2
29	0.0137	0.0776	82.3	30	0.0046	0.0613	92.5
31	0.0129	0.0726	82.2	32	0.0045	0.0575	92.2
33	0.0119	0.0682	82.5	34	0.0046	0.0541	91.5
35	0.0118	0.0643	81.6	36	0.0044	0.0511	91.3
37	0.0118	0.0608	80.6	38	0.0044	0.0484	91.0
39	0.0105	0.0577	81.9	40	0.0044	0.0460	90.3

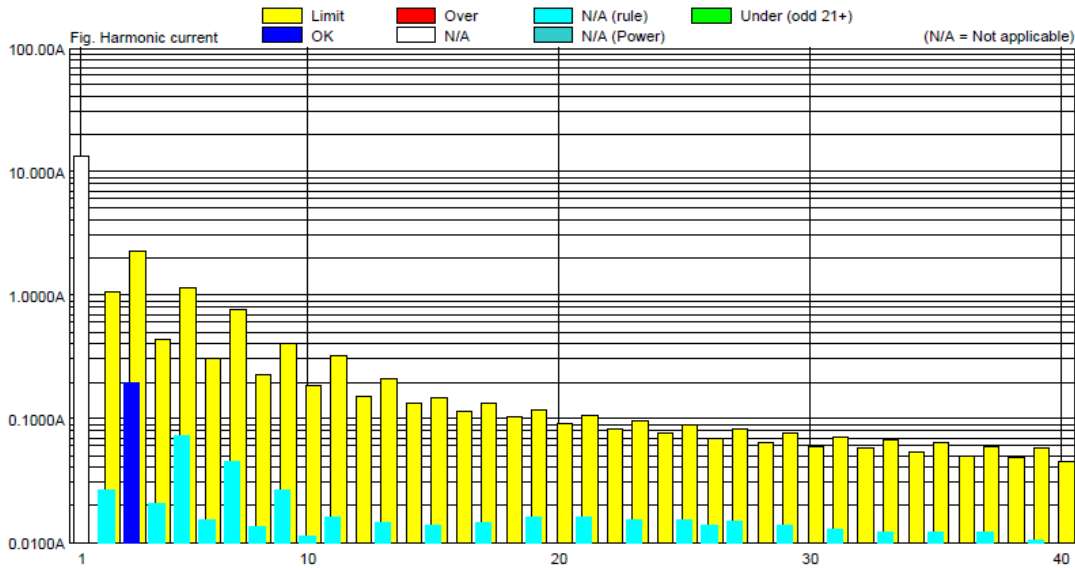



BUREAU VERITAS

Test Report No.: CE190808N030

Maximum

Regulation : IEC61000-3-2 Ed3.0 am2
 IEC61000-4-7 Ed2.0 A1
 Class : CLASS A
 MeasureTime : 149.80sec
 Model : YOKOGAWA WT3000
 Rating Voltage : 230.00 V
 Wiring : single-phase 2-wire
 Element : 1
 Range : 300V/30A
 Current(rms) : 13.5022 A
 Voltage(rms) : 230.54 V
 Frequency : 50.007 Hz
 Power Factor : 0.9934
 Beyond Limit Time : 14.9801 s
 Beyond Total Time : 0.0000 s
 THC : 0.2303 A

PASS

Set Fundamental I : -----
 Set Power Factor : -----
 Set P : -----
 Sigma W Max : 3091.754 W
 Sigma PF : 0.9934
 Distortion factor(V) : 0.05 %
 V THDS : 0.05 %
 V THDG : 0.05 %
 Distortion factor(A) : 1.69 %
 A THDS : 1.72 %
 A THDG : 1.76 %
 P THD : 0.00 %
 Power Limit : 75 W

Order	Measure[A]	Limit[A]	Margin[%]	Order	Measure[A]	Limit[A]	Margin[%]
1	13.5002			2	0.0288	1.6200	98.2
3	0.1986	3.4500	94.2	4	0.0221	0.6450	96.6
5	0.0750	1.7100	95.6	6	0.0170	0.4500	96.2
7	0.0468	1.1550	96.0	8	0.0154	0.3450	95.5
9	0.0280	0.6000	95.3	10	0.0132	0.2760	95.2
11	0.0186	0.4950	96.2	12	0.0106	0.2300	95.4
13	0.0165	0.3150	94.8	14	0.0088	0.1971	95.5
15	0.0153	0.2250	93.2	16	0.0078	0.1725	95.5
17	0.0154	0.1985	92.2	18	0.0068	0.1533	95.6
19	0.0169	0.1776	90.5	20	0.0064	0.1380	95.4
21	0.0169	0.1607	89.5	22	0.0069	0.1255	94.5
23	0.0161	0.1467	89.0	24	0.0066	0.1150	94.2
25	0.0168	0.1350	87.5	26	0.0159	0.1062	...
27	0.0155	0.1250	87.6	28	0.0059	0.0986	94.1
29	0.0146	0.1164	87.5	30	0.0053	0.0920	94.3
31	0.0137	0.1089	87.5	32	0.0051	0.0862	94.1
33	0.0127	0.1023	87.6	34	0.0051	0.0812	93.7
35	0.0127	0.0964	86.9	36	0.0050	0.0767	93.5
37	0.0126	0.0912	86.2	38	0.0049	0.0726	93.2
39	0.0112	0.0865	87.0	40	0.0050	0.0690	92.7

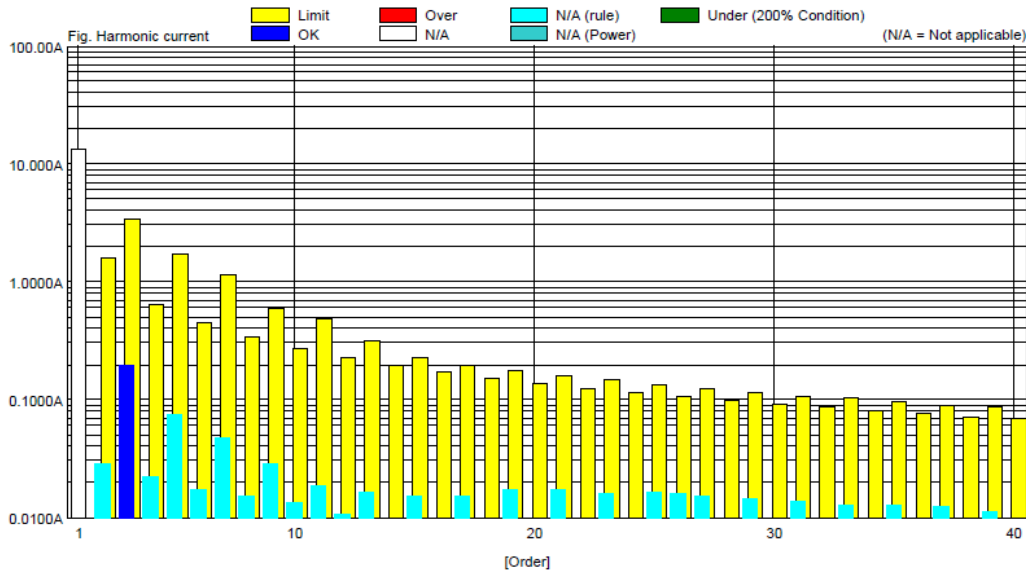



BUREAU VERITAS

Test Report No.: CE190808N030

FOR MODEL HYD 6000-ES

Regulation : IEC61000-3-12
IEC61000-4-7 Ed2.0 A1
MeasureTime : 150sec
Model : YOKOGAWA WT3000
Wiring : single-phase 2-wire
Element : 1
Range : 300V/400.0A
Rating Voltage : 230 V
Iequ : 15.0000 A
Z Impedance : 0.1200 ohm
I1 : 25.7299 A
Power Rsce : 127.778
Max Rsce : 33.000

PASS

Ssc : 341550.00
Min Rsce : 33.0000
Apply Limit : equipment other than balanced 3-phase.
Situation1 : 0.94% (Pass)
Term a : 4.04 - 69.42deg (Fail)
Term c(I5) : 0.21% (Pass)
Term c(I7) : 0.22% (Pass)

[Average]
Voltage(rms) : 230.89 V
Current(rms) : 25.73 A
Frequency : 50.00 Hz
Power Factor : 1.00
Sigma W : 5925.18 W
THC : 0.29 A
V THD : 0.04 %
A THD : 1.14 %
P THD : 0.00 %

[Maximum]
Voltage(rms) : 230.90 V
Current(rms) : 25.76 A
Frequency : 50.01 Hz
Power Factor : 1.00
Sigma W : 5930.65 W
THC : 0.30 A
V THD : 0.04 %
A THD : 1.25 %
P THD : 0.00 %

Table with 3 columns: Order Measure[%], Limit[%], Margin[%]. Rows 2-13 and THD, PWHD.

Table with 3 columns: Order Measure[%], Limit[%], Margin[%]. Rows 2-13 and THD, PWHD.

Legend: Limit (yellow), OK (blue), N/A (rule) (cyan), Limit Over (red), N/A (white)

Legend: Limit (yellow), OK (blue), N/A (rule) (cyan), Limit Over (red), N/A (white)

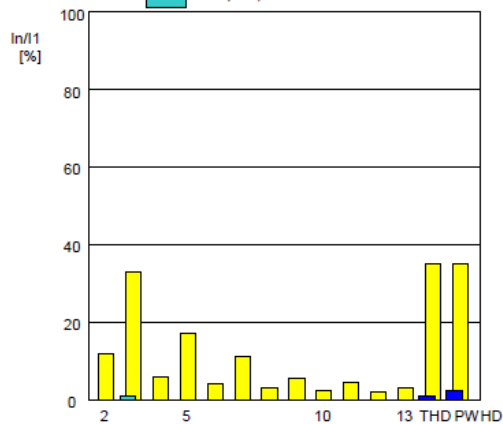
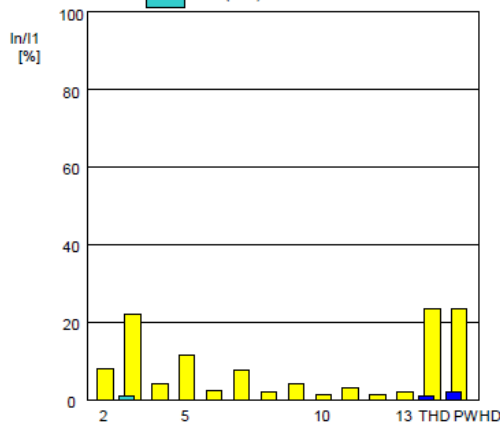



3.4 VOLTAGE FLUCTUATION AND FLICKS MEASUREMENT

TEST STANDARD: EN 61000-3-3 and EN 61000-3-11

3.4.1 TEST INSTRUMENTS

DESCRIPTION & MANUFACTURER	MANUFACTURER	MODEL NO.	SERIAL NO.	CALIBRATED DATE	CALIBRATED UNTIL
PRECISION POWER ANALYZER	YOKOGAWA	WT3000	91M210852	Mar. 07, 2018	Mar. 06, 2019
Test Software	YOKOGAWA	IEC61000	N/A	N/A	N/A
REFERENCE IMPEDANCE NETWORK	Voltech	EUR	3018	N/A	N/A

- NOTE:** 1. The test was performed in PV Room.
 2. The calibration interval of the above test instruments is 12 months and the calibrations are traceable to CEPREI/CHINA and NIM/CHINA

3.4.2 TEST PROCEDURE

- The EUT was placed on the top of a wooden table 0.8 meters above the ground and operated to produce the most unfavorable sequence of voltage changes under Normal Operating conditions.
- During the flick measurement, the measure time shall include that part of whole operation cycle in which the EUT produce the most unfavorable sequence of voltage changes. The observation period for short-term flicker indicator is 120 minutes

3.4.3 DEVIATION FROM TEST STANDARD

No deviation

3.4.4 TEST SETUP

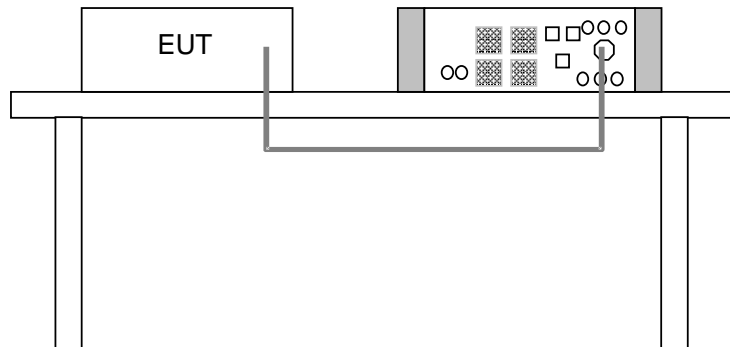

3.4.5 EUT OPERATING CONDITIONS

Same as item 3.1.6



3.4.6 TEST RESULTS

FOR MODEL HYD 3000-ES

Regulation : IEC61000-3-3 Ed2.0
 IEC61000-4-15 Ed1.1
 Interval : 10Min0Sec
 Model : YOKOGAWA WT3000
 Wiring : single-phase 2wire
 Voltage Range : 300.00V
 Voltage U1 : 235.60V
 Set Frequency : 50Hz
 Frequency U1 : 49.999Hz
 Element : 1
 dmin : 0.10%

PASS

Element1 : Pass
 dc (3.30%) : Pass
 dmax (4.00%) : Pass
 d(t) (500ms) : Pass
 Pst (1.00) : Pass
 Plt (0.65) : Pass

No.	dc[%]	dmax[%]	d(t)[ms]	Pst
1	0.05	0.14	0.00	0.14
2	0.00	0.00	0.00	0.14
3	0.00	0.00	0.00	0.14
4	0.00	0.00	0.00	0.14
5	0.00	0.00	0.00	0.14
6	0.00	0.00	0.00	0.14
7	0.00	0.00	0.00	0.14
8	0.00	0.00	0.00	0.14
9	0.00	0.00	0.00	0.14
10	0.00	0.00	0.00	0.14
11	0.00	0.00	0.00	0.14
12	0.00	0.00	0.00	0.14

Plt
 0.14

FOR MODEL HYD 6000-ES

Regulation : IEC61000-3-11 Ed1.0
 IEC61000-4-15 Ed1.1
 Interval : 10Min0Sec
 Model : YOKOGAWA WT3000
 Wiring : single-phase 2wire
 Voltage Range : 300.00V
 Voltage U1 : 239.95V
 Set Frequency : 50Hz
 Frequency U1 : 50.000Hz
 Element : 1
 dmin : 0.10%

PASS

Compatibility Condition : Compliance with IEC61000-3-3
 Element1 : Pass
 dc (3.30%) : Pass
 dmax (4.00%) : Pass
 d(t) (500ms) : Pass
 Pst (1.00) : Pass
 Plt (0.65) : Pass

No.	dc[%]	dmax[%]	d(t)[ms]	Pst
1	0.11	0.24	0.00	0.25
2	1.17	1.29	0.00	0.35
3	0.07	1.25	0.00	0.36
4	0.05	1.25	0.00	0.36
5	0.39	1.25	0.00	0.36
6	0.35	1.24	0.00	0.36
7	0.07	1.26	0.00	0.36
8	0.39	1.26	0.00	0.36
9	0.06	1.26	0.00	0.36
10	0.38	1.23	0.00	0.36
11	0.37	1.26	0.00	0.36
12	0.05	1.28	0.00	0.36

Plt
 0.35



4 IMMUNITY TEST

4.1 GENERAL DESCRIPTION

4.1.1 GENERAL DESCRIPTION OF EN 61000-6-2

Product Standard:	EN 61000-6-2:2005	
Basic Standard, specification requirement, and Performance Criteria:	IEC 61000-4-2	Electrostatic Discharge – ESD: 4kV Contact discharge, 8kV air discharge, Performance Criterion B
	IEC 61000-4-3	Radio-Frequency Electromagnetic Field Susceptibility Test – RS: 80-1000 MHz, 10V/m, 80% AM (1kHz), 1400-2000 MHz, 3V/m, 80% AM (1kHz) 2000-2700 MHz, 1V/m, 80% AM (1kHz) Performance Criterion A
	IEC 61000-4-4	Electrical Fast Transient/Burst - EFT AC Power line: 2kV, DC Power line: 2kV Signal line: 1kV Performance Criterion B
	IEC 61000-4-5	Surge Immunity Test: 1.2/50 us Open Circuit Voltage, 8 /20 us Short Circuit Current, AC Power Line: line to line 1 kV, line to earth 2kV DC Power Line: line to line 0.5kV line to earth 0.5kV Signal line: 1kV Performance Criterion B
	IEC 61000-4-6	Conducted Radio Frequency Disturbances Test – CS: 0.15-80 MHz, 10Vrms, 80% AM, 1kHz, Performance Criterion A
	IEC 61000-4-8	Power Frequency Magnetic Field Test, 50 Hz, 30A/m, Performance Criterion A



4.1.2 PERFORMANCE CRITERIA

According to Clause 4 of EN 61000-6-2:2005 standard, the following describes the general performance criteria.

CRITERION A	The apparatus shall continue to operate as intended during and after the test. No degradation of performance or loss of function is allowed below a performance level specified by the manufacturer, when the apparatus is used as intended. The performance level may be replaced by a permissible loss of performance. If the minimum performance level or the permissible performance loss is not specified by the manufacturer, either of these may be derived from the product description and documentation and what the user may reasonably expect from the apparatus if used as intended.
CRITERION B	The apparatus shall continue to operate as intended after the test. No degradation of performance or loss of function is allowed below a performance level specified by the manufacturer, when the apparatus is used as intended. The performance level may be replaced by a permissible loss of performance. During the test, degradation of performance is however allowed. No change of actual operating state or stored data is allowed. If the minimum performance level or the permissible performance loss is not specified by the manufacturer, either of these may be derived from the product description and documentation and what the user may reasonably expect from the apparatus if used as intended.
CRITERION C	Temporary loss of function is allowed, provided the function is self-recoverable or can be restored by the operation of the controls.

4.1.3 EUT OPERATING CONDITION

Same as item 3.1.6



4.2 ELECTROSTATIC DISCHARGE IMMUNITY TEST (ESD)

4.2.1 TEST SPECIFICATION

Basic Standard:	IEC 61000-4-2
Discharge Impedance:	330 ohm / 150 pF
Discharge Voltage:	Air Discharge: 8 kV (Direct) Contact Discharge: 4 kV (Indirect)
Polarity:	Positive & Negative
Number of Discharge:	20 times at each test point
Discharge Mode:	Single Discharge
Discharge Period:	1 second

4.2.2 TEST INSTRUMENTS

Equipment	Manufacturer	Model No.	Serial No.	Last Cal.	Next Cal.
ESD Generator	TESEQ	NSG 437	279	Mar. 31,18	Mar. 30,19
Test Software	TESEQ	V03.03	N/A	N/A	N/A
ESD Generator	EM TEST	Dito	V1211112265	Jan. 16,18	Jan. 15,19
Test Software	EM TEST	V 2.31	N/A	N/A	N/A

- NOTE:** 1. The test was performed in ESD Room.
2. The calibration interval of the above test instruments is 12 months and the calibrations are traceable to CEPREI/CHINA, GRGT/CHINA and NIM/CHINA.



4.2.3 TEST PROCEDURE

The basic test procedure was in accordance with IEC 61000-4-2:

- a. Electrostatic discharges were applied only to those points and surfaces of the EUT that are accessible to users during normal operation.
- b. The test was performed with at least ten single discharges on the pre-selected points in the most sensitive polarity.
- c. The time interval between two successive single discharges was at least 1 second.
- d. The discharge return cable of the generator shall be kept at a distance of at least 0.2 m from the EUT whilst the discharge is being applied and should not be held by the operator.
- e. Contact discharges were applied to the non-insulating coating, with the pointed tip of the generator penetrating the coating and contacting the conducting substrate.
- f. Air discharges were applied with the round discharge tip of the discharge electrode approaching the EUT as fast as possible (without causing mechanical damage) to touch the EUT. After each discharge, the ESD generator was removed from the EUT and re-triggered for a new single discharge. The test was repeated until all discharges were complete.
- g. At least ten single discharges (in the most sensitive polarity) were applied to the **Horizontal Coupling Plane** at points on each side of the EUT. The ESD generator was positioned horizontal at a distance of 0.1 meters from the EUT with the discharge electrode touching the **HCP**.
- h. At least ten single discharges (in the most sensitive polarity) were applied to the center of one vertical edge of the **Vertical Coupling Plane** in sufficiently different positions that the four faces of the EUT were completely illuminated. The **VCP** (dimensions 0.5m x 0.5m) was placed vertically to and 0.1 meters from the EUT.

4.2.4 DEVIATION FROM TEST STANDARD

No Deviation



4.2.5 TEST SETUP

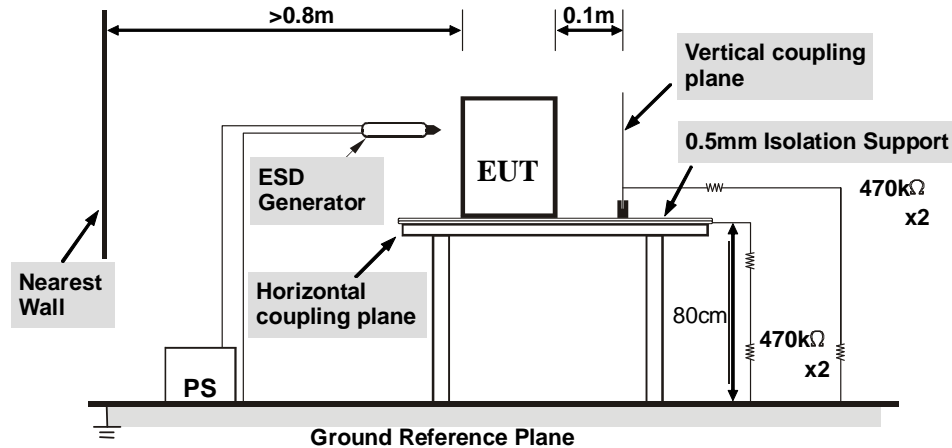

NOTE:

TABLE-TOP EQUIPMENT

The configuration consisted of a wooden table 0.8 meters high standing on the **Ground Reference Plane**. The **GRP** consisted of a sheet of aluminum at least 0.25mm thick, and 2.5 meters square connected to the protective grounding system. A **Horizontal Coupling Plane** (1.6m x 0.8m) was placed on the table and attached to the **GRP** by means of a cable with 940kΩ total impedance. The equipment under test, was installed in a representative system as described in section 7 of IEC 61000-4-2, and its cables were placed on the **HCP** and isolated by an insulating support of 0.5mm thickness. A distance of 0.8-meter minimum was provided between the EUT and the walls of the laboratory and any other metallic structure.

FLOOR-STANDING EQUIPMENT

The equipment under test was installed in a representative system as described in section 7 of IEC 61000-4-2, and its cables were isolated from the Ground Reference Plane by an insulating support of 0.1-meter thickness. The GRP consisted of a sheet of aluminum that is at least 0.25mm thick, and 2.5 meters square connected to the protective grounding system and extended at least 0.5 meters from the EUT on all sides.



4.2.6 TEST RESULTS

TEST MODE	See items 2.2	TEST VOLTAGE	See items 2.2
ENVIRONMENTAL CONDITIONS	24.3deg. C, 43.8% RH 101.5kPa	TESTED BY: Hu	

Direct Discharge Application				
Test Level (kV)	Polarity	Test Point	Test Result of Contact Discharge	Test Result of Air Discharge
4	+/-	All Metal Part	A	N/A
8	+/-	All Non-metal Part	N/A	A

Indirect Discharge Application				
Discharge Level (kV)	Polarity	Test Point	Test Result of HCP	Test Result of VCP
4	+/-	HCP	A	N/A
4	+/-	VCP	N/A	A

NOTE: A: There was no change compared with initial operation during the test.

(○ - Direct Contact Discharge; -Air Discharge)

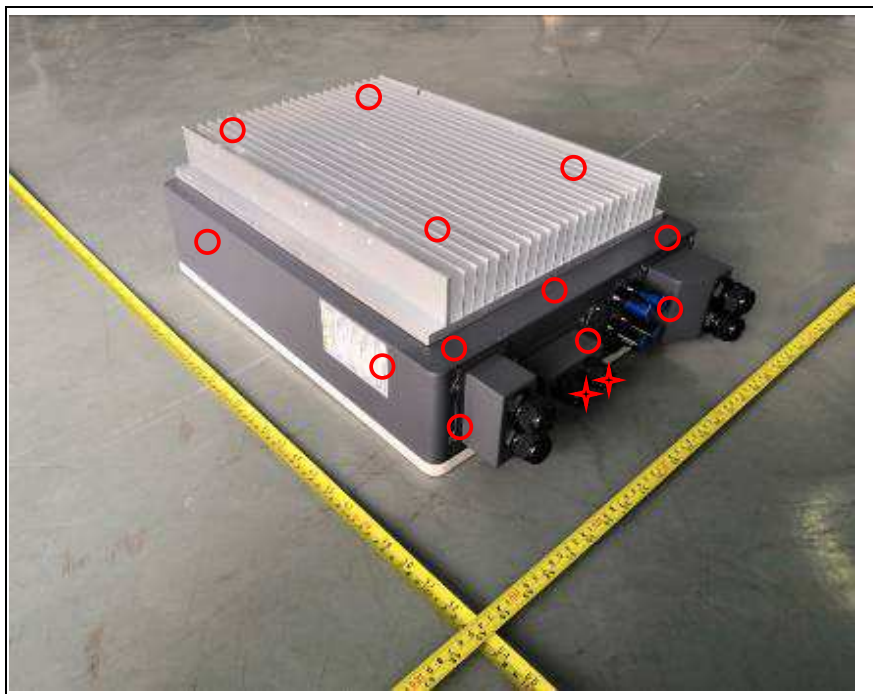



4.3 RADIATED, RADIO-FREQUENCY, ELECTROMAGNETIC FIELD IMMUNITY TEST (RS)

4.3.1 TEST SPECIFICATION

Basic Standard:	IEC 61000-4-3
Frequency Range:	80-1000MHz, 1400-2000MHz, 2000-2700MHz
Field Strength:	10V/m, 3V/m,1V/m
Modulation:	1kHz Sine Wave, 80%, AM Modulation
Frequency Step:	1 % of fundamental
Polarity of Antenna:	Horizontal and Vertical
Antenna Height:	1.5m
Dwell Time:	at least 3 seconds

4.3.2 TEST INSTRUMENTS

Equipment	Manufacturer	Model No.	Serial No.	Last Cal.	Next Cal.
Signal Generator	Agilent	N5181A	MY50142530	Oct. 20,17	Oct. 19,18
Antenna Log-Periodic	AR	ATR80M6G	0337307	N/A	N/A
Antenna Log-Periodic	AR	ATS700M11G	0336821	N/A	N/A
Switch Controller	AR	SC1000	0337343	N/A	N/A
RF Power Meter	ESE	4242	13984	Jan. 02,18	Jan. 01,19
Power Sensor	ESE	51011EMC	35716	Jan. 02,18	Jan. 01,19
Power Sensor	ESE	51011EMC	35715	Jan. 02,18	Jan. 01,19
E-Field probe	Narda	NBM-520	2403/01B	Sep. 28,18	Sep. 27,19
Power Amplifier	TESEQ	CBA 1G-150	T44029	N/A	N/A
Power Amplifier	TESEQ	CBA 3G-100	T44030	N/A	N/A
Power Amplifier	TESEQ	CBA 6G-050	1041204	N/A	N/A
Dual Directional Coupler	TESEQ	C5982	95208	Nov. 08,17	Nov. 07,18
Dual Directional Coupler	TESEQ	C6187	95175	Nov. 08,17	Nov. 07,18
Dual Directional Coupler	TESEQ	CPH-274F	M251304-01	Nov. 08,17	Nov. 07,18
Test Software	Tonscend	TS+	2.5.0.0	N/A	N/A
Test Software	ADT	BVADT_RS_V 7.6.4-DG	N/A	N/A	N/A

- NOTE:**
1. The test was performed in RS chamber.
 2. The calibration interval of the above test instruments is 12 months and the calibrations are traceable to CEPREI/CHINA, GRGT/CHINA and NIM/CHINA.



4.3.3 TEST PROCEDURE

The test procedure was in accordance with IEC 61000-4-3

- a. The testing was performed in a fully-anechoic chamber.
- b. The frequency range is swept from 80 MHz to 1000 MHz, 1400MHz to 2000MHz, 2000MHz to 2700MHz with the signal 80% amplitude modulated with a 1kHz sine wave.
- c. The dwell time at each frequency shall not be less than the time necessary for the EUT to be exercised and to respond, but shall in no case be less than 0,5s.
- d. The field strength levels were 10V/m, 3V/m, 1V/m.
- e. The test was performed with the EUT exposed to both vertically and horizontally polarized fields on each of the four sides.

4.3.4 DEVIATION FROM TEST STANDARD

No Deviation

4.3.5 TEST SETUP

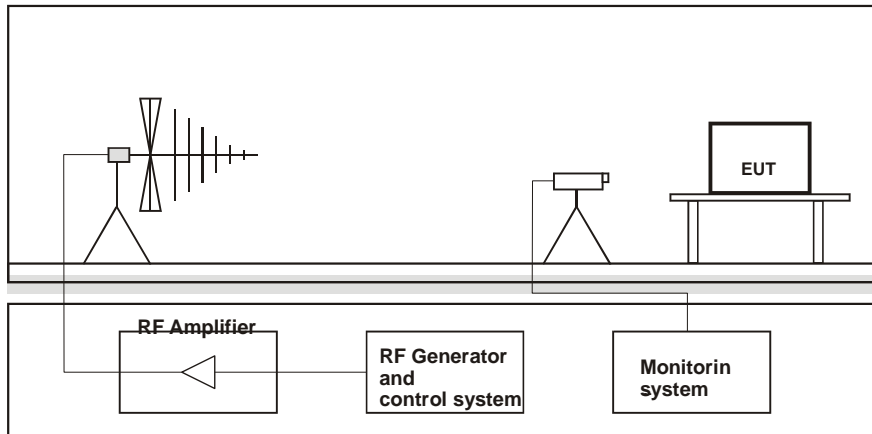

NOTE:

TABLETOP EQUIPMENT

The EUT installed in a representative system as described in section 7 of IEC 61000-4-3 was placed on a non-conductive table 0.8 meters in height. The system under test was connected to the power and signal wire according to relevant installation instructions.

FLOOR STANDING EQUIPMENT

The EUT installed in a representative system as described in section 7 of IEC 61000-4-3 was placed on a non-conductive wood support 0.1 meters in height. The system under test was connected to the power and signal wire according to relevant installation instructions.



4.3.6 TEST RESULTS

TEST MODE	See items 2.2	TEST VOLTAGE	See items 2.2
ENVIRONMENTAL CONDITIONS	26.7deg. C, 57.8% RH	TESTED BY: Andy	

Field Strength (V/m)	Test Frequency Note#1 (MHz)	Polarization of antenna (Horizontal / Vertical)	Test Distance (m)	Test Result	Remark
10	80 - 1000	H&V	3	A	N/A
3	1400 - 2000	H&V	3	A	N/A
1	2000 - 2700	H&V	3	A	N/A

Note#1:

Tested Israel SII Frequencies 89,100,107,144,163,196,244,315,434,460,600,825,845,880 MHz

NOTE: A: There was no change compared with initial operation during the test.



4.4 ELECTRICAL FAST TRANSIENT/BURST IMMUNITY TEST (EFT)

4.4.1 TEST SPECIFICATION

Basic Standard:	IEC 61000-4-4
Test Voltage:	Power Line/DC Line: 2kV
Polarity:	Positive & Negative
Impulse Frequency:	5 kHz
Impulse Waveshape :	5/50 ns
Burst Duration:	15 ms
Burst Period:	300 ms
Test Duration:	1 min.

4.4.2 TEST INSTRUMENTS

Equipment	Manufacturer	Model No.	Serial No.	Last Cal.	Next Cal.
Combination wave Module	TESEQ	CDN 3061	1361	May 02,18	May 01,19
Telecom Surge Module	TESEQ	NSG 3060 Mainframe	1404	May 02,18	May 01,19
Automated 3-Phase Coupling/ Decoupling Network	TESEQ	CDN 3063	2131	May 02,18	May 01,19
CDN	TESEQ	CDN HSS-2	34275	May 02,18	May 01,19
CDN	TESEQ	CDN 118	30741	May 02,18	May 01,19
Test Software	TESEQ	CDM 3061_0002.30	1361	N/A	N/A
Test Software	TESEQ	HVM 3060_0002.30	293	N/A	N/A
EFT Tester	HAEFELY	PEFT4010	150546	May 02,18	May 01,19
EFT Coupling Clamp	HAEFELY	IP4A	150407	May 02,18	May 01,19

- NOTE:** 1. The test was performed in EMS Room.
 2. The calibration interval of the above test instruments is 12 months and the calibrations are traceable to CEPREI/CHINA, GRGT/CHINA and NIM/CHINA.

4.4.3 TEST PROCEDURE

- Both positive and negative polarity discharges were applied.
- The length of the “hot wire” from the coaxial output of the EFT generator to the terminals on the EUT should not exceed 0.5 meter ± 0.05 meter.
- The duration time of each test sequential was 1 minute.
- The transient/burst waveform was in accordance with IEC 61000-4-4, 5/50ns.

4.4.4 DEVIATION FROM TEST STANDARD

No deviation.



4.4.5 TEST SETUP

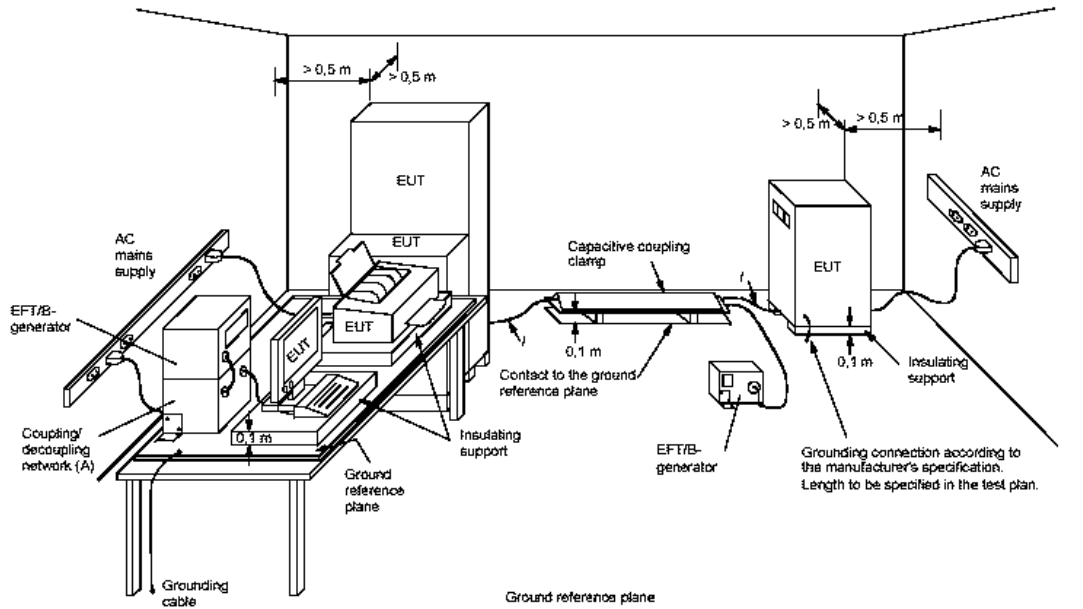

NOTE: **TABLETOP EQUIPMENT**

The configuration consisted of a wooden table standing on the Ground Reference Plane and should be located 0.1 m +/- 0.01 m above the Ground Reference Plane.

The GRP consisted of a sheet of aluminum (at least 0.25 mm thick and 2.5 m square) connected to the protective grounding system. A minimum distance of 0.5 m was provided between the EUT and the walls of the laboratory or any other metallic structure.

FLOOR STANDING EQUIPMENT

The EUT installed in a representative system as described in section 7 of IEC 61000-4-4 and its cables, were isolated from the Ground Reference Plane by an insulating support that is 0.1-meter thick. The GRP consisted of a sheet of aluminum (at least 0.25 mm thick and 2.5 m square) connected to the protective grounding system.



4.4.6 TEST RESULTS

TEST MODE	See items 2.2	TEST VOLTAGE	See items 2.2
ENVIRONMENTAL CONDITIONS	25.6 deg. C, 58.4% RH	TESTED BY: Jack	

Pulse Voltage	2.0 kV		kV		kV		kV	
	+	-	+	-	+	-	+	-
L	A	A	/	/	/	/	/	/
N	A	A	/	/	/	/	/	/
PE	A	A	/	/	/	/	/	/
L+N	A	A	/	/	/	/	/	/
L+PE	A	A	/	/	/	/	/	/
N+PE	A	A	/	/	/	/	/	/
L+N+PE	A	A	/	/	/	/	/	/
DC Line	A	A	/	/	/	/	/	/

NOTE: A: There was no change compared with initial operation during the test.



4.5 SURGE IMMUNITY TEST

4.5.1 TEST SPECIFICATION

Basic Standard:	IEC 61000-4-5
Wave-Shape:	Combination Wave 1.2/50 us Open Circuit Voltage 8 /20 us Short Circuit Current
Test Voltage:	AC Power Line :Line to Line: 1kV Line to PE: 2kV
Surge Input/Output:	L-N, L-PE, N-PE
Generator Source	2 ohm between networks
Impedance:	12 ohm between network and ground
Polarity:	Positive/Negative
Phase Angle:	0° /90°/180°/270°
Pulse Repetition Rate:	1 time / 60 sec.
Number of Tests:	5 positive and 5 negative at selected points

4.5.2 TEST INSTRUMENTS

Equipment	Manufacturer	Model No.	Serial No.	Last Cal.	Next Cal.
Combination wave Module	TESEQ	CDN 3061	1361	May 02,18	May 01,19
Telecom Surge Module	TESEQ	NSG 3060 Mainframe	1404	May 02,18	May 01,19
Automated 3- Phase Coupling/ Decoupling Network	TESEQ	CDN 3063	2131	May 02,18	May 01,19
CDN	TESEQ	CDN HSS-2	34275	May 02,18	May 01,19
CDN	TESEQ	CDN 118	30741	May 02,18	May 01,19
Test Software	TESEQ	CDM 3061_0002.30	1361	N/A	N/A
Test Software	TESEQ	HVM 3060_0002.30	293	N/A	N/A

- NOTE:** 1. The test was performed in EMS Room.
2. The calibration interval of the above test instruments is 12 months and the calibrations are traceable to CEPREI/CHINA, GRGT/CHINA and NIM/CHINA.



4.5.3 TEST PROCEDURE

a. For EUT power supply:

The surge is to be applied to the EUT power supply terminals via the capacitive coupling network. Decoupling networks are required in order to avoid possible adverse effects on equipment not under test that may be powered by the same lines, and to provide sufficient decoupling impedance to the surge wave. The power cord between the EUT and the coupling/decoupling networks shall be 2 meters in length (or shorter).

b. For test applied to unshielded unsymmetrically operated interconnection lines of EUT:

The surge is applied to the lines via the capacitive coupling. The coupling / decoupling networks shall not influence the specified functional conditions of the EUT. The interconnection line between the EUT and the coupling/decoupling networks shall be 2 meters in length (or shorter).

c. For test applied to unshielded symmetrically operated interconnection / telecommunication lines of EUT:

The surge is applied to the lines via gas arrestors coupling. Test levels below the ignition point of the coupling arrestor cannot be specified. The interconnection line between the EUT and the coupling/decoupling networks shall be 2 meters in length (or shorter).

4.5.4 DEVIATION FROM TEST STANDARD

No deviation.

4.5.5 TEST SETUP

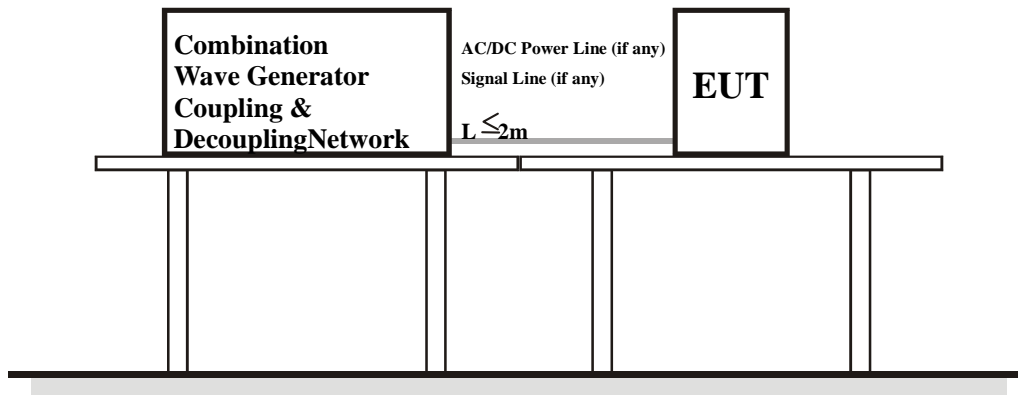



4.5.6 TEST RESULTS

TEST MODE	See items 2.2	TEST VOLTAGE	See items 2.2
ENVIRONMENTAL CONDITIONS	24.8deg. C, 56.7% RH	TESTED BY: Jack	

AC/DC Power port:

\Voltage (kV)	\Phase angle \ Test point	\ Test result \ Polarity	0°	90°	180°	270°	DC Power Port
1.0	L-N	+	B	B	B	B	N/A
		-	B	B	B	B	N/A
2.0	L-PE	+	B	B	B	B	N/A
		-	B	B	B	B	N/A
2.0	N-PE	+	B	B	B	B	N/A
		-	B	B	B	B	N/A
0.5	DC Line	+	N/A	N/A	N/A	N/A	A
		-	N/A	N/A	N/A	N/A	A

NOTE: A: There was no change compared with initial operation during the test.
 B: The EUT would reduce power and restart during the test, and it could recover automatically.



4.6 IMMUNITY TO CONDUCTED DISTURBANCES INDUCED BY RF FIELDS (CS)

4.6.1 TEST SPECIFICATION

Basic Standard:	IEC 61000-4-6
Frequency Range:	0.15 MHz - 80 MHz
Field Strength:	10V _{r.m.s}
Modulation:	1kHz Sine Wave, 80%, AM Modulation
Frequency Step:	1 % of fundamental
Coupled Cable:	Power Mains & DC Power Line
Coupling Device:	CDN-M3 (3 wires) & Clamp

4.6.2 TEST INSTRUMENTS

Equipment	Manufacturer	Model No.	Serial No.	Last Cal.	Next Cal.
Signal Generator	Rohde&Schwarz	SME06	829498/006	Oct. 20,17	Oct. 19,18
CDN	Luthi	L-801M2/M3	2015	Sep.27,18	Sep. 26,19
CDN(AUX)	TESEQ	CDN M016	27452	Nov. 15,17	Nov. 14,18
CDN	TESEQ	T200A	26944	Apr. 11,18	Apr. 10,19
CDN	TESEQ	T400A	26536	Apr. 11,18	Apr. 10,19
CDN	TESEQ	ST08A	32256	Apr. 11,18	Apr. 10,19
6dB 50Watt Attenuator	HUBER+SUHNER	5906.17.0005	303688	Oct. 20,17	Oct. 19,18
Power Amplifier	PRANA	DR 220	1512-1788	NA	NA
Electromagnetic Injection Clamp	Luthi	EM101	35640	Sep.14,18	Sep. 13,19
Test Software	Tonscend	TS+	2.5.0.0	N/A	N/A
Test Software	ADT	BVADT_CS_V 7.6.2	N/A	N/A	N/A

- NOTE:** 1. The test was performed in CS test room.
2. The calibration interval of the above test instruments is 12 months and the calibrations are traceable to CEPREI/CHINA, GRGT/CHINA and NIM/CHINA.



4.6.3 TEST PROCEDURE

- a. The EUT shall be tested within its intended operating and climatic conditions.
- b. An artificial hand was placed on the hand-held accessory and connected to the ground reference plane.
- c. The test shall be performed with the test generator connected to each of the coupling and decoupling devices in turn, while the other non-excited RF input ports of the coupling devices are terminated by a 50-ohm load resistor.
- d. The frequency range is swept from 150 kHz to 80 MHz, using the signal level established during the setting process and with a disturbance signal of 80 % amplitude. The signal is modulated with a 1 kHz sine wave, pausing to adjust the RF signal level or the switch coupling devices as necessary. Where the frequency is swept incrementally, the step size shall not exceed 1 % of the preceding frequency value.
- e. The dwell time of the amplitude modulated carrier at each frequency shall not be less than the time necessary for the EUT to be exercised and to respond, but shall in no case be less than 0,5 s. The sensitive frequencies (e.g. clock frequencies) shall be analyzed separately.
- f. Attempts should be made to fully exercise the EUT during testing, and to fully interrogate all exercise modes selected for susceptibility.

4.6.4 DEVIATION FROM TEST STANDARD

No deviation.



4.6.5 TEST SETUP

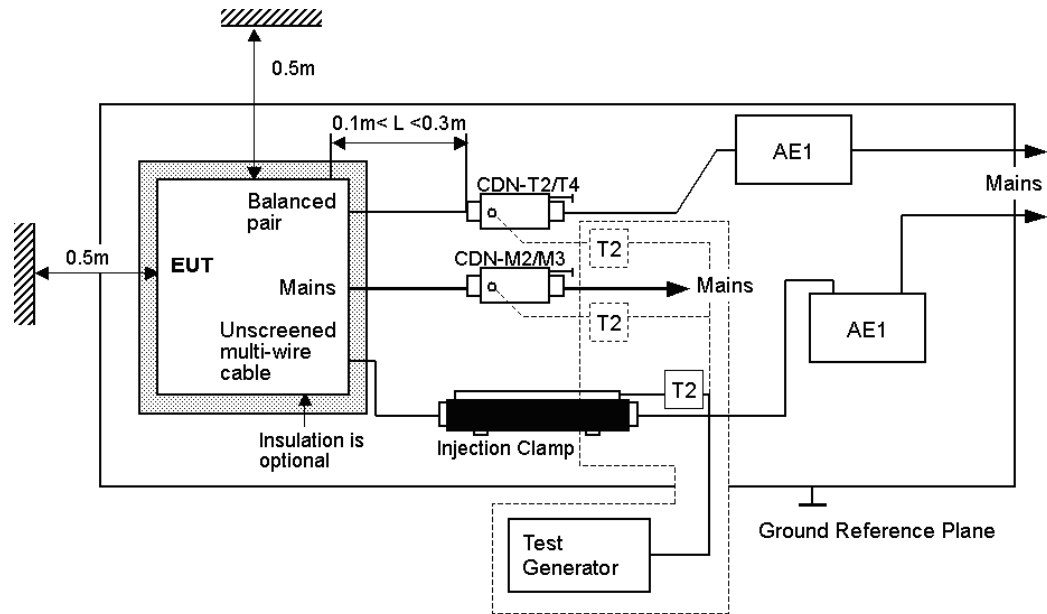

NOTE: The EUT clearance from any metallic obstacles shall be at least 0.5m.

All non-excited input ports of the CDNs shall be terminated by 50Ω loads.

NOTE:

FLOOR-STANDING EQUIPMENT

The equipment to be tested is placed on an insulating support of 0.1 meters height above a ground reference plane. All relevant cables shall be provided with the appropriate coupling and decoupling devices at a distance between 0.1 meters and 0.3 meters from the projected geometry of the EUT on the ground reference plane.



4.6.6 TEST RESULTS

TEST MODE	See items 2.2	TEST VOLTAGE	See items 2.2
ENVIRONMENTAL CONDITIONS	26.8deg. C, 57.6% RH	TESTED BY: Andy	

Voltage (V)	Test Frequency Note#1 (MHz)	Tested Line	Injection Method.	Test Result	Remark
10	0.15 – 80	AC Line	CDN-M3	A	N/A
10	0.15 – 80	DC Line	Clamp	A	N/A

Note#1: Tested Israel SII Frequencies 0.2,0.53,1,1.5,7.1,13.56,21,27.12,40.68,65,68 MHz

NOTE: A: There was no change compared with initial operation during the test.



4.7 POWER FREQUENCY MAGNETIC FIELD IMMUNITY TEST

4.7.1 TEST SPECIFICATION

Basic Standard:	IEC 61000-4-8
Frequency Range:	50Hz
Field Strength:	30A/m
Observation Time:	5 minute
Inductance Coil:	Rectangular type, 1mx1m

4.7.2 TEST INSTRUMENTS

Equipment	Manufacturer	Model No.	Serial No.	Last Cal.	Next Cal.
Magnetic Field Tester	HAEFELY	MAG100.1	150579	Oct. 20,17	Oct. 19,18
Test Software	N/A	N/A	N/A	N/A	N/A

- NOTE:** 1. The test was performed in Shielding Room 843.
 2. The calibration interval of the above test instruments is 12 months and the calibrations are traceable to CEPREI/CHINA, GRGT/CHINA and NIM/CHINA.

4.7.3 TEST PROCEDURE

- a. The equipment is configured and connected to satisfy its functional requirements.
- b. The power supply, input and output circuits shall be connected to the sources of power supply, control and signal.
- c. The cables supplied or recommended by the equipment manufacturer shall be used. 1 meter of all cables used shall be exposed to the magnetic field.

4.7.4 DEVIATION FROM TEST STANDARD

No deviation.



4.7.5 TEST SETUP

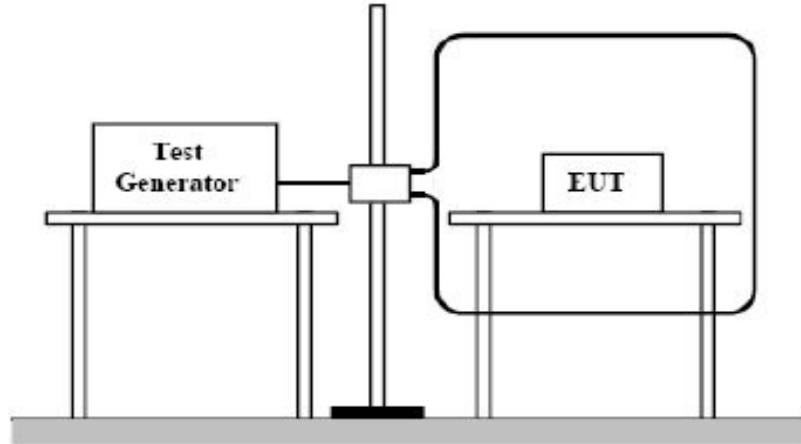

NOTE:

TABLETOP EQUIPMENT

The equipment shall be subjected to the test magnetic field by using the induction coil of standard dimension (1 m x 1 m). The induction coil shall then be rotated by 90 degrees in order to expose the EUT to the test field with different orientations.

FLOOR-STANDING EQUIPMENT

The equipment shall be subjected to the test magnetic field by using induction coils of suitable dimensions. The test shall be repeated by moving and shifting the induction coils, in order to test the whole volume of the EUT for each orthogonal direction. The test shall be repeated with the coil shifted to different positions along the side of the EUT, in steps corresponding to 50 % of the shortest side of the coil. The induction coil shall then be rotated by 90 degrees in order to expose the EUT to the test field with different orientations.



4.7.6 TEST RESULTS

TEST MODE	See items 2.2	TEST VOLTAGE	See items 2.2
ENVIRONMENTAL CONDITIONS	24.8 deg. C, 56.7% RH	TESTED BY: Jack	

Magnetic field direction	Testing result	Remark
X - Axis	A	30A/m
Y - Axis	A	30A/m
Z - Axis	A	30A/m

NOTE: A: There was no change compared with initial operation during the test.



5 PHOTOGRAPHS OF THE TEST CONFIGURATION

CONDUCTED EMISSION TEST



RADIATED EMISSION TEST (30MHz~1GHz)

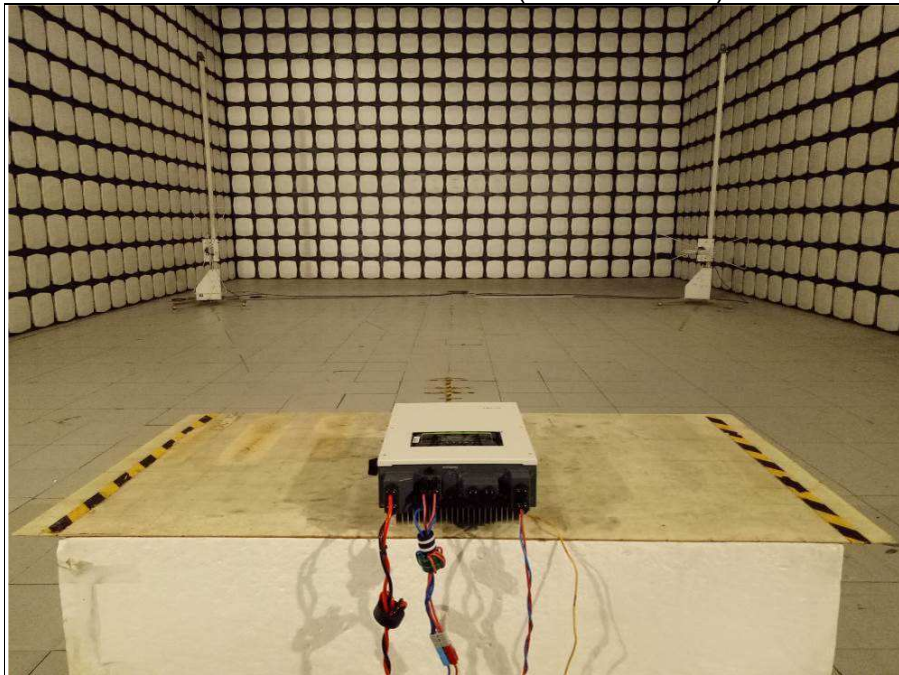



**BUREAU
VERITAS**

Test Report No.: CE190808N030

ESD TEST



RS TEST





BUREAU
VERITAS

Test Report No.: CE190808N030

EFT TEST

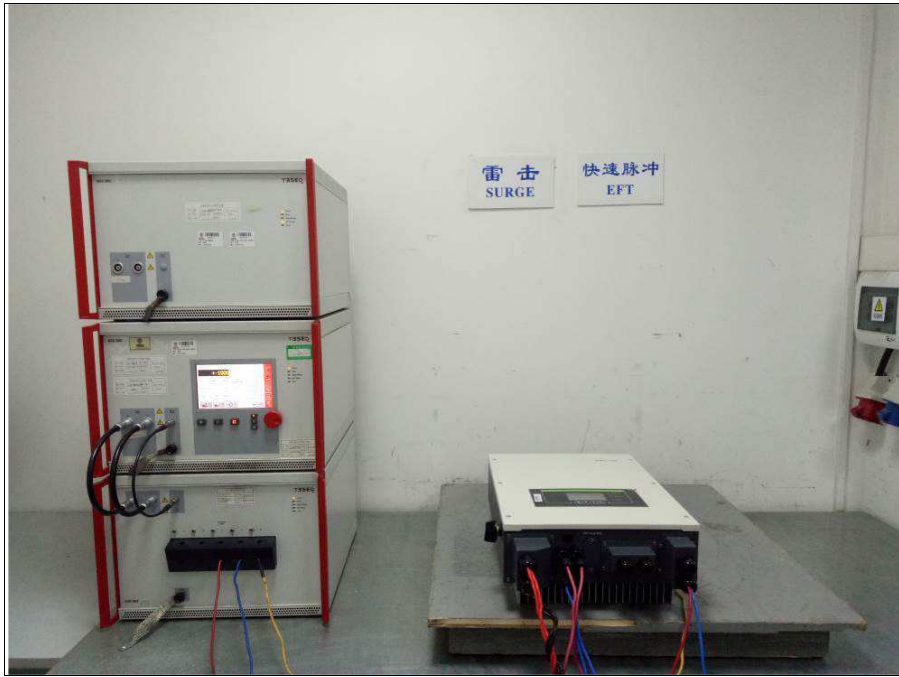

EFT AT DC LINE TEST





BUREAU
VERITAS

Test Report No.: CE190808N030

SURGE TEST



CONDUCTED SUSCEPTIBILITY TEST

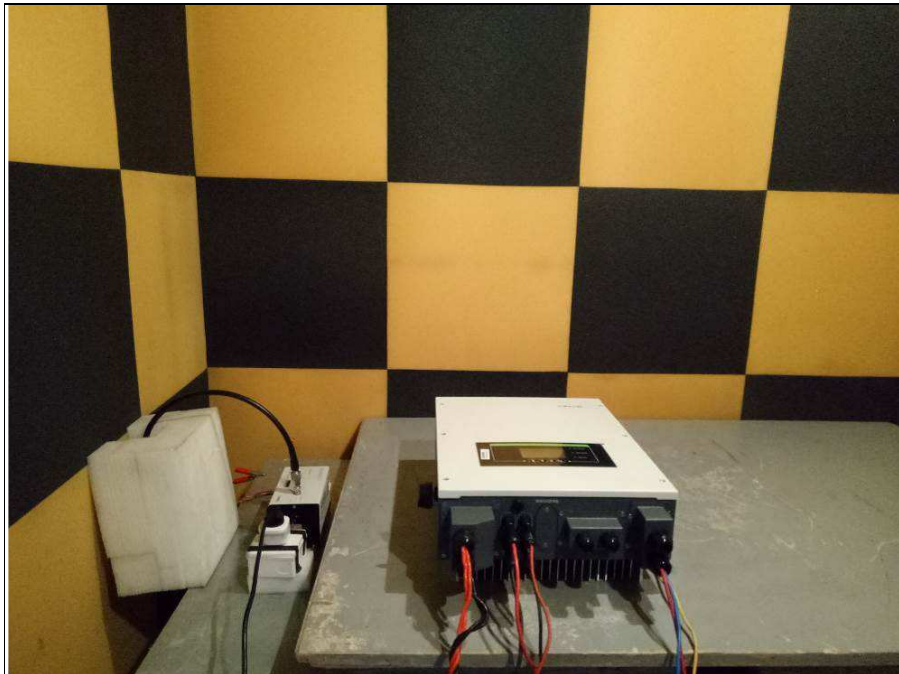



**BUREAU
VERITAS**

Test Report No.: CE190808N030

CONDUCTED SUSCEPTIBILITY AT DC LINE TEST



POWER-FREQUENCY MAGNETIC FIELDS TEST

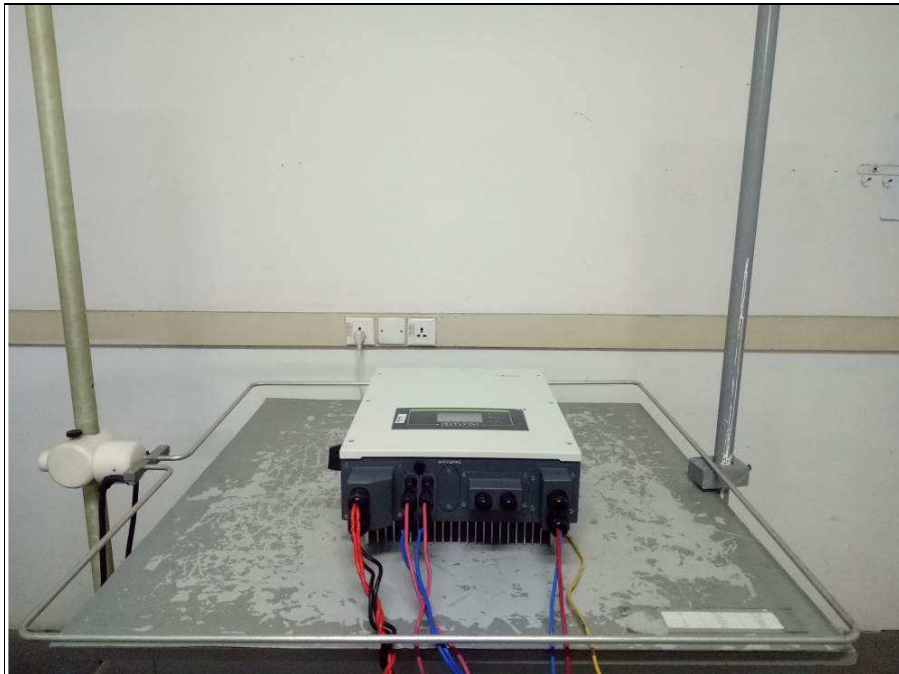



**BUREAU
VERITAS**

Test Report No.: CE190808N030

6 APPENDIX A – MODIFICATIONS RECORDERS FOR ENGINEERING CHANGES TO THE EUT BY THE LAB

No any modifications were made to the EUT by the lab during the test.

---END---